

Mini, 7/8"-Round-Plug Connector, Double-Ended Cordsets, US Color Code

RSRK 201...601A | RSRKW 201...601A



2-, 3-, 4-, 5-, and 6-Poles

Mini, 7/8" double-ended cordsets, male to female straight, 2-, 3-, 4-, 5-, and 6-poles with molded cable, US color code.

RSRK

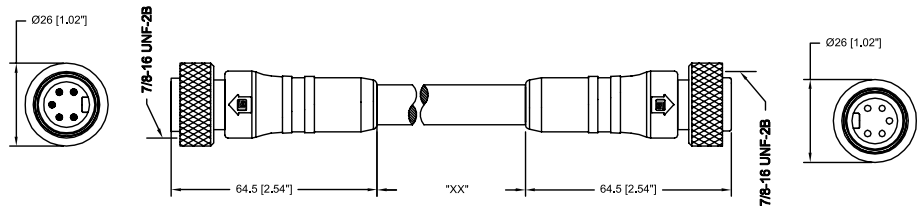

Mini, 7/8" double-ended cordsets, male straight to female 90°, 2-, 3-, 4-, 5-, and 6-poles with molded cable, US color code.

RSRKW

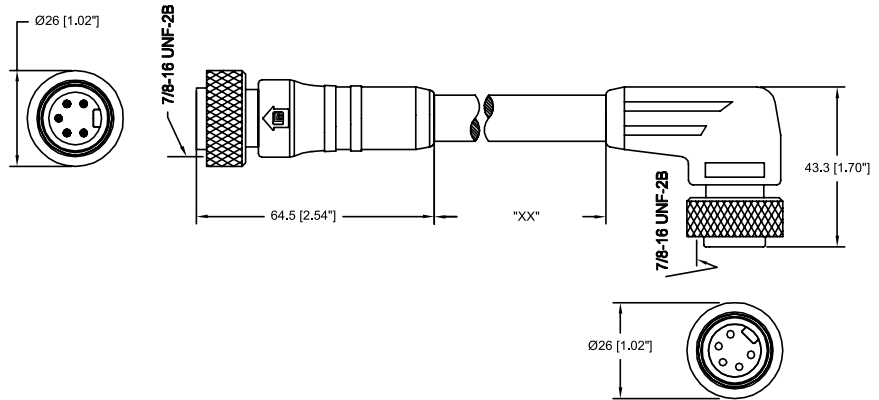

Pin Assignments

Mini, 7/8" - Male / Female

2 poles

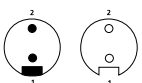

1 = white
2 = black

3 poles

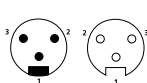

1 = green
2 = black
3 = white

4 poles

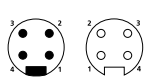

1 = black
2 = white
3 = red
4 = green

5 poles

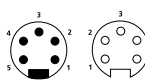

1 = white
2 = red
3 = green
4 = orange
5 = black

6 poles

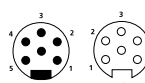

1 = white
2 = red
3 = green
4 = orange
5 = black
6 = blue



Mini, 7/8"-Round-Plug Connector, Double-Ended Cordsets, US Color Code RSRK 201...601A | RSRKW 201...601A

Technical Data

Environmental

Degree of protection IP 67 / NEMA 6P
Operating temperature range -40°C (-40°F) / +90°C (194°F)

Mechanical

Housing / Molded body TPU, yellow
Insert TPU, yellow
Contact CuZn, gold over silver plated
Coupling nut Aluminum, anodized black

























Electrical

Current rating 2 pole: 12 A
3-5 pole: 8 A
6 pole: 5 A

Voltage rating 600 V

Cable Specifications - US Color Code

Cable No.	Outer Jacket	Gauge	Jacket Color	OD	Temperature Rating	Agency Approvals
619	CPE	18AWG	Yellow	.370" (9.4 mm)	-40°C (-40°F) to +90°C (194°F)	UL: S00W / CSA: S0W
678	PVC	16AWG	Yellow	.375" (9.5 mm)	-40°C (-40°F) to +105°C (221°F)	UL: ST0W / CSA: ST0
697	PVC	18AWG	Yellow	.502" (12.8 mm)	-40°C (-40°F) to +105°C (221°F)	UL: ST0W / CSA: ST00
738	TPE	16AWG	Yellow	.390" (9.9 mm)	-50°C (-58°F) to +105°C (221°F)	UL: SE00W / CSA: ST00W
739	TPE	16AWG	Yellow	.415" (10.5 mm)	-50°C (-58°F) to +105°C (221°F)	UL: SE00W / CSA: ST00W
777	TPE	16AWG	Yellow	.495" (12.6 mm)	-50°C (-58°F) to +105°C (221°F)	UL: SE00W / CSA: ST00W
839	TPE	16AWG	Yellow	.342" (8.7 mm)	-30°C (-22°F) to +90°C (194°F)	UL: TC-ER
877	TPE	16AWG	Yellow	.371" (9.4 mm)	-30°C (-22°F) to +90°C (194°F)	UL: TC-ER

Part Number	Pins	Outer Jacket	Standard Cable Lengths	Characteristics
RSRK 201-678/...F	2	PVC	6 F / 12 F / 15 F / 20 F / 30 F	  
RSRK 301-619/...F	3	CPE	6 F / 12 F / 15 F / 20 F / 30 F	  
RSRK 301-738/...F	3	TPE	6 F / 12 F / 15 F / 20 F / 30 F	  
RSRK 401-739/...F	4	TPE	6 F / 12 F / 15 F / 20 F / 30 F	  
RSRK 401-839/...M	4	TPE	1 M / 2 M / 3 M / 5 M / 10 M / 20 M	    
RSRK 501-777/...F	5	TPE	6 F / 12 F / 15 F / 20 F / 30 F	  
RSRK 501-877/...M	5	TPE	1 M / 2 M / 3 M / 5 M / 10 M / 20 M	    
RSRK 601A-697/...F	6	PVC	6 F / 12 F / 15 F / 20 F / 30 F	