

RSRK 20...50 | RSRKW 20...50



Mini, 7/8\"/>

2-, 3-, 4- and 5-Poles

Mini, 7/8" double-ended cordsets, male straight with external threads to female straight connector, 2-, 3-, 4-, and 5-poles with molded cable, IEC color code.

RSRK

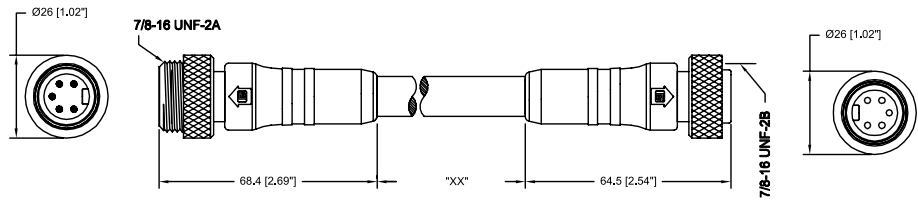

Mini, 7/8" double-ended cordsets, male straight with external threads to female 90° connector, 2-, 3-, 4-, and 5-poles with molded cable, IEC color code.

RSRKW

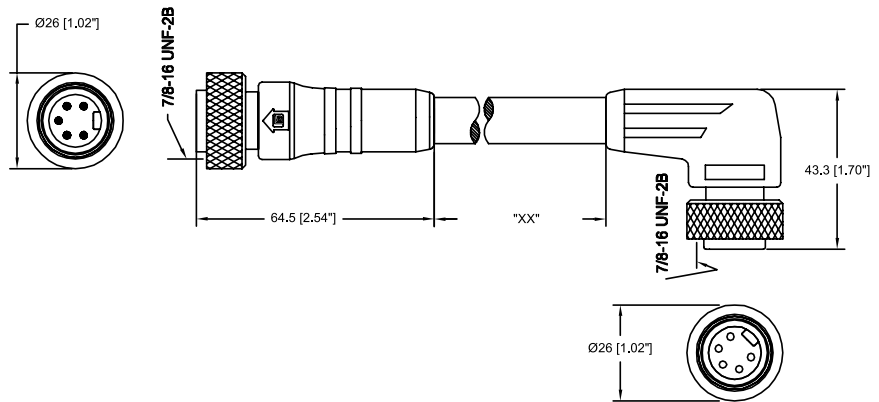

Pin Assignments

Mini, 7/8\"/>

2 poles

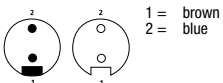

3 poles

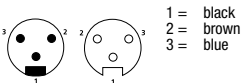

4 poles

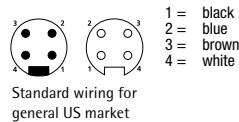
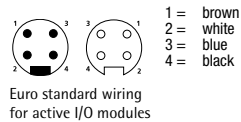

5 poles

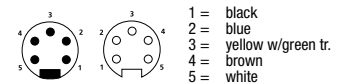

Be Certain with Belden



Cordsets
Double-Ended

Mini, 7/8"-Round-Plug Connector, Double-Ended Cordsets, IEC Color Code RSRK 20...50 | RSRKW 20...50

Technical Data

Environmental

Degree of protection IP 67 / NEMA 6P
Operating temperature range -40°C (-40°F) / +90°C (194°F)

Mechanical

Housing / Molded body TPU, yellow
Insert TPU, yellow
Contact CuZn, gold over silver plated
Coupling nut Aluminum, anodized black

Electrical

Current rating 2-3 pole: 8 A
4-5 pole: 5.6 A
Voltage rating 300 V

Cable Specifications - IEC Color Code

Cable No.	Outer Jacket	Gauge	Jacket Color	OD	Temperature Rating	Agency Approvals
602	PUR	18AWG	Yellow	.230" (5.8 mm)	-40°C (-40°F) to +80°C (176°F)	UL: AWM 20233 / CSA: AWM I/II A/B
Continuous flex rating and suitable for general C-track usage. 1 million cycles at minimum bend radius 10X cable diameter.						
603	PVC	18AWG	Yellow	.290" (7.4 mm)	-40°C (-40°F) to +105°C (221°F)	UL: AWM 2661 / CSA: AWM I/II A/B
637	TPE	18AWG	Yellow	.280" (7.1 mm)	-40°C (-40°F) to +105°C (221°F)	UL: PLTC / CSA: AWM I/II A/B
645	PUR	18AWG	Yellow	.220" (5.6 mm)	-40°C (-40°F) to +80°C (176°F)	UL: AWM 20233 / CSA: AWM I/II A/B
731	TPE	18AWG	Yellow	.284" (7.2 mm)	-40°C (-40°F) to +90°C (194°F)	UL: PLTC / CSA: AWM I/II A/B
794	TPE	18AWG	Yellow	.304" (7.7 mm)	-40°C (-40°F) to +90°C (194°F)	UL: PLTC / CSA: AWM I/II A/B

Part Number	Pins	Outer Jacket	Standard Cable Lengths	Characteristics
RSRK 20-603/...M	2	PVC	0.3 M / 0.6 M / 1 M / 2 M / 5 M	
RSRK 30-731/...F	3	TPE	6 F / 12 F / 15 F / 20 F / 30 F	
RSRK 30-645/...M		PUR	0.3 M / 0.6 M / 1 M / 2 M / 5 M	
RSRK 40-637/...F	4	TPE	6 F / 12 F / 15 F / 20 F / 30 F	
RSRK 40-602/...M		PUR	0.3 M / 0.6 M / 1 M / 2 M / 5 M	
RSRK 50-794/...F	5	TPE	6 F / 12 F / 15 F / 20 F / 30 F	