

## Fieldbus Communications

### AS-Interface

**AS-i (Actuator Sensor Interface)** was designed as a simple system for the quick data exchange of binary signals. Research, spawned by market demands, has made it possible to transmit analog data as well (also see "The new AS-i-specification V2.1"). That data, however, must not be time-critical, since the transmission of an analog value requires several data cycles.

The biggest advantage of AS-i is the quick and uncomplicated installation of the system. Communication (Manchester Encoding) and power supply are transmitted via a 2-wire cable. By using piercing technology for contacting the cable it is possible to insert a new slave at any point in the system. In addition, the arbitrary structure of the bus (line, tree, star, ...) permits the perfect adaptation to the relevant plant or machine.

AS-i is mainly used for small machines, as a subsystem for more complex bus systems (e.g. PROFIBUS-DP) or as an easy introduction to bus technology.

AS-Interface is an open standard. Thus, it is possible to operate different bus participants made by different manufacturers in one network.

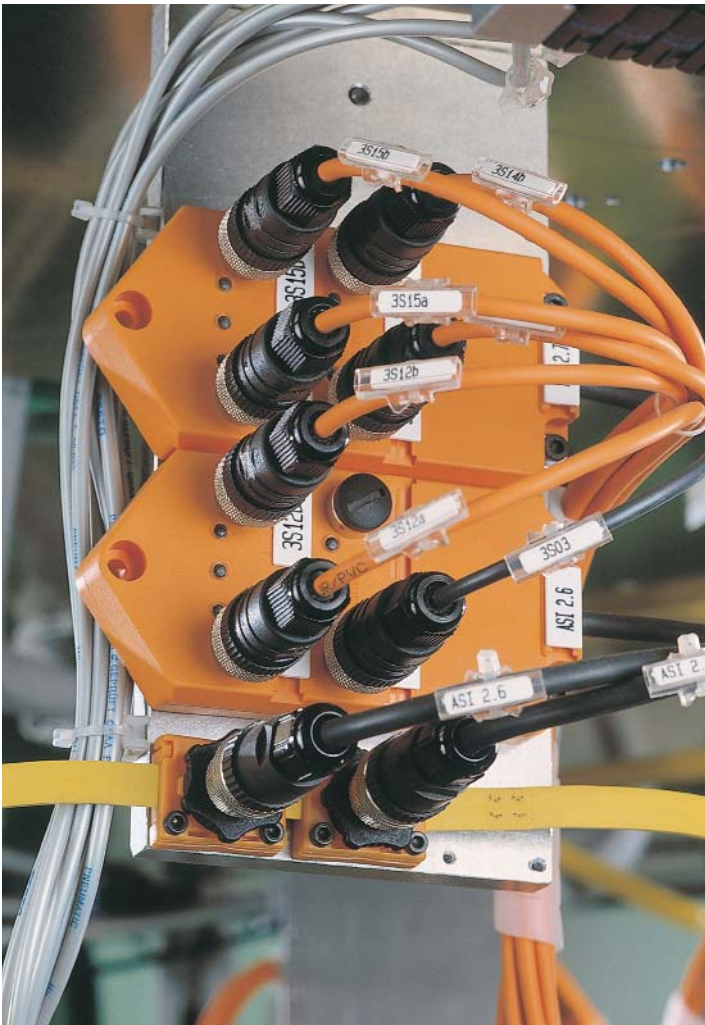

## Lumberg Products

Lumberg remains true to the AS-i easy installation concept and offers compact, solid module technology to the customer. The IP67 components have been designed to use directly on machines.

The flat cable shown below is commonly used with AS-i. However, for some applications such as C-tracks, Lumberg provides connections for round cable for all modules as well.

## Technical Data

### Transmission media

- Unshielded 2-wire cable for power supply (module electronics and sensors) and data transmission (Manchester Encoding)
- Optionally mechanically encoded flat or round cable

### Network topology

The bus can be built arbitrarily (line, star, tree, ...). Terminating resistors are not required.

### Bus access

- Monomaster system
- Master-slave access

### Number of slaves

31 slaves by using standard slaves  
62 slaves by using A/B slaves with profile 2.1

### Standard transmission rates and segment lengths

- Transmission rate: 167 kbaud
- Max. segment length: 100 m

### Bus cycle time

- Standard slaves  
max. 5 ms in case of full arrangement (31 slaves)
- Just A or B slave per address  
max. 5 ms in case of full arrangement (31 slaves)
- A and B slave per address  
max. 10 ms in case of full arrangement (62 slaves)

### Addressing

AS-i slaves are generally addressed via software (the default address is generally "0" for all AS-i slaves). This can be done in several ways:

- Via the master: The slaves are connected to the master consecutively. The latter automatically identifies the kind of slave and starts communicating. Then the slave can be addressed.
- Via an addressing unit: All AS-i slaves can be addressed with the standard addressing unit "0913 ATL 003" (the Lumberg flat cable modules require the adapter "0913 ATL 002 / 0.35M"; modules according to profile 2.1 require the adapter "0913 ATL 004 / 1 M).

- **Automatic addressing:** If a slave in a network fails, AS-i offers the option of auto-addressing. The defective slave is replaced by an identical one. The master identifies this slave and automatically addresses it to the address of the missing slave.

**Diagnostic system**







According to the AS-i specification 2.1 periphery errors like short circuit or overload can be sent to the master in the form of a collective diagnostic. In addition, there is a status LED on the relevant slave.

**The new AS-i specification version 2.1**

With the introduced AS-i specification V. 2.1 some innovations have been integrated into the AS-i system. The most important alteration is the possibility to operate 62 (instead of 31) slaves in one network. This became possible by the introduction of a differentiation between A and B slaves (e.g. 1A + 1B). To achieve that, the system had to be designed with one output per slave less (max. 4I/30).

The new specification is downward compatible, and old AS-i slaves can be operated in one network together with new ones. In addition to that, the processing of analog values was improved. The transmission of analog values are integrated in the master. This means that specific function blocks need not be used any more.

**Product Characteristics**

-  Especially suitable for robotic applications (resistance to torsion).
-  Very good resistance to oils, coolants and lubricants as well as emulsions.
-  Suitable for use in C-Tracks.
-  Very good resistance to flying weld slag (e.g.) unfinished constructions).
-  Very good resistance to acids, lye and chemical cleaning agents.
-  Very good electromagnetic resistance (EMC) and shielded systems.
-  Very good vibration and shock resistance.
-  UL approved.
-  CSA approved.

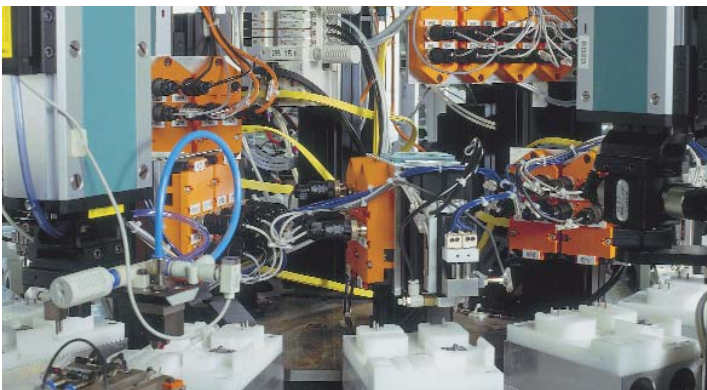

	AS-i-Specification < V. 2.1	AS-i-Specification V. 2.1
<b>Slave</b>	Standard	A/B slave
<b>max. number of slaves</b>	31	62
<b>max. number of inputs</b>	4 I x 31 slaves = 124 I	4 Inputs x 62 slaves = 248 Inputs
<b>max. number of outputs</b>	4 O x 31 slaves = 124 O	3 Outputs x 62 slaves = 186 Outputs (one output is needed for the A/B addressing)
<b>Cycle time</b>	5ms for 31 slaves	10ms for 62 slaves
<b>Analog value processing</b>	via functional blocks	integrated in the master

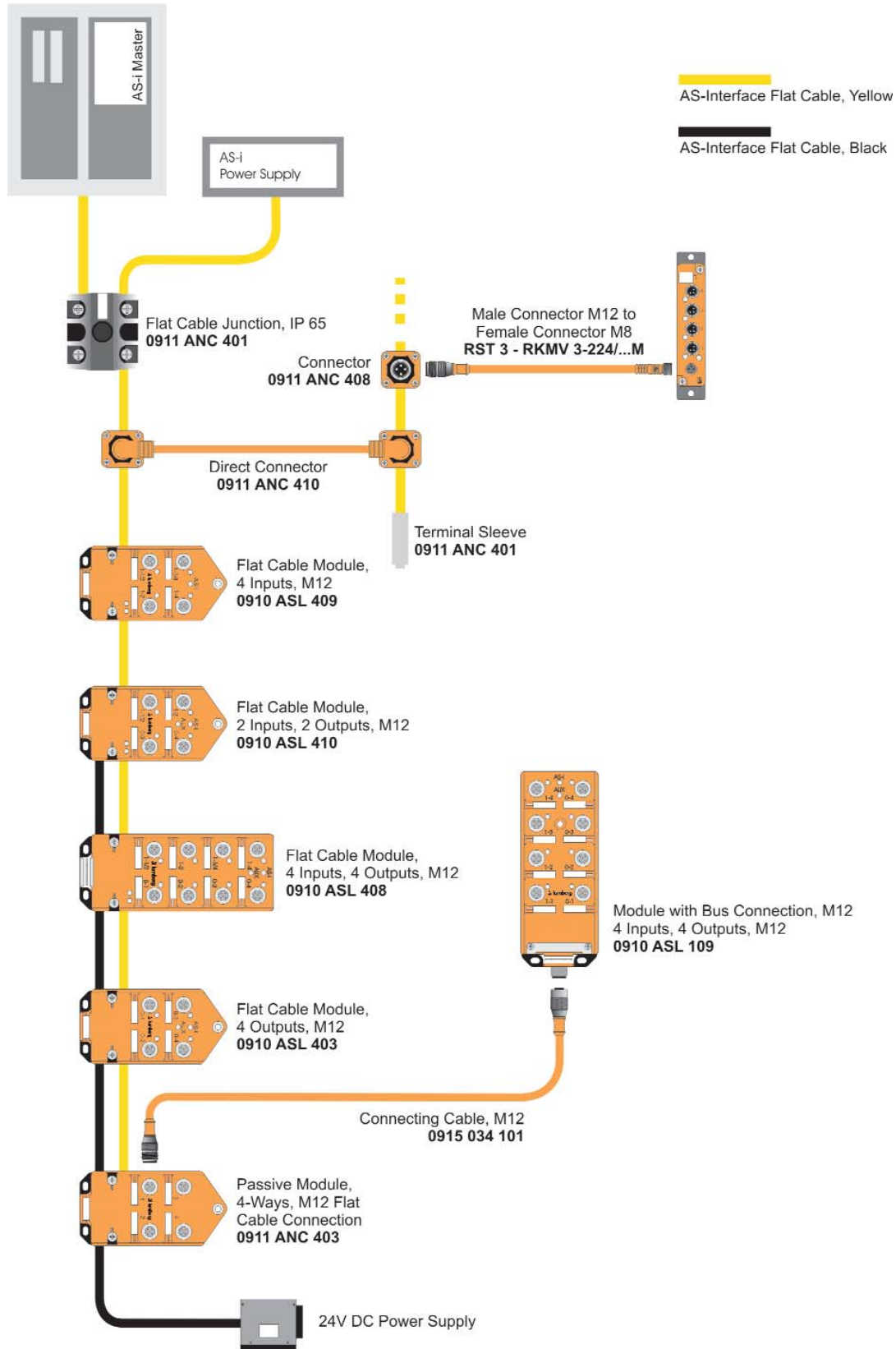

4 In



**0910 ASL 501**

AS-Interface module with 4 digital inputs (PNP) and pico (M8) bus connection.

page **10-11**

4 In



**0910 ASL 409 / 0910 ASL 132**

AS-Interface module with 4 digital inputs (PNP) and flat cable or Micro (M12) bus connector.

page **12-15**

8 In



**0910 ASL 412**

AS-Interface module with 8 digital inputs (PNP) and flat cable bus connection.

page **16-17**

4 Out



**0910 ASL 403 / 0910 ASL 133**

AS-Interface module with 4 digital outputs (2A) and flat cable or Micro (M12) bus connector.

page **18-21**

8 Out



**0910 ASL 419**

AS-Interface module with 8 digital outputs (0.5A) and flat cable bus connection.

page **22-23**

**2 In / 2 Out**



**0910 ASL 410 / 0910 ASL 134**

AS-Interface module with 2 digital inputs (PNP), 2 digital outputs (2A) and flat cable or Micro (M12) bus connecton.

page **24-27**

**4 In / 3 Out**



**0910 ASL 414**

AS-Interface module with 4 digital inputs (PNP), 3 digital outputs (2A) and flat cable bus connecton.

page **28-29**

**4 In / 4 Out**



**0910 ASL 408 / 0910 ASL 135**

AS-Interface module with 4 digital inputs (PNP), 4 digital outputs (2A) and flat cable or Micro (M12) bus connecton.

page **30-33**

**4 In / 4 Out**



**0910 ASL 424 / 0910 ASL 425**

AS-Interface module with 4 digital inputs (PNP), 4 digital outputs (2A), with or without Y-wiring sceme, and Micro (M12) bus connecton.

page **34-37**



**0915 034 101**

AS-Interface PUR round cable ; double ended; molded male and female micro (M12) connectors, length 1M.

page **38**

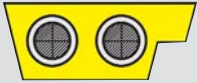

**0915 097 000-50 M / 0915 098 000-50 M**

AS-Interface rubber flat cable for bus / auxillary power, 50m spool.

page **39**



**0915 145 000-50 M / 0915 146 000-50 M**

AS-Interface TPE flat cable; yellow or black outer jacket for bus / power supply, 50m spool.

page **39**

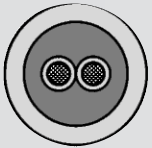

**0915 041 000**

AS-Interface PUR/PVC round cable; orange outer jacket for bus.

page **40**



**0911 ANC 002 / 0911 ANC 403**

AS-Interface passive distribution blocks.

page **41-42**



**0911 ANC 001/1.5 M / 0911 ANC 101 / 0911 ANC 401**

AS-Interface flat cable junctions.

page **43**

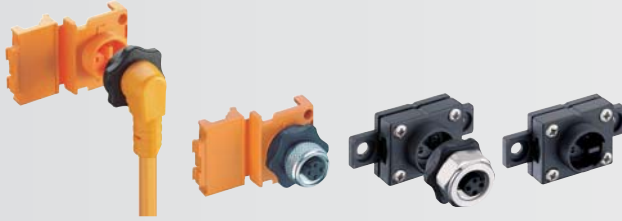

**0911 ANC 407/...M / 0911 ANC 410 / 0911 ANC 408 /**

**0911 ANC 406 / 0911 ANC 413 / 0911 ANC 415**

AS-Interface flat cable junction connectors with piercing technology.

page **44-45**



**0913 ATL 003**

AS-Interface addressing handheld, AS-i profile V2.1, direct connection for round cable modules.

page **46**



**0913 ATL 002/0.35 M / 0913 ATL 004/1 M**

AS-Interface addressing adapters for 0913 ATL 003.

page **46**



**0911 ANC 409 / ZBS / ZVK**

Terminal sleeve for flat cables / Attachable labels, 10 pieces (7 x 14mm) / Dust cover for unused M12 sockets.

page **46**





## 0910 ASL 501

Version 2.1 - 4 In

AS-Interface module with 4 digital inputs (PNP) and Pico (M8) bus connecton. Features: AS-i profile V2.1, short circuit detection, protection degree IP67 / NEMA 6P, shock and vibration protected by using potting technology.

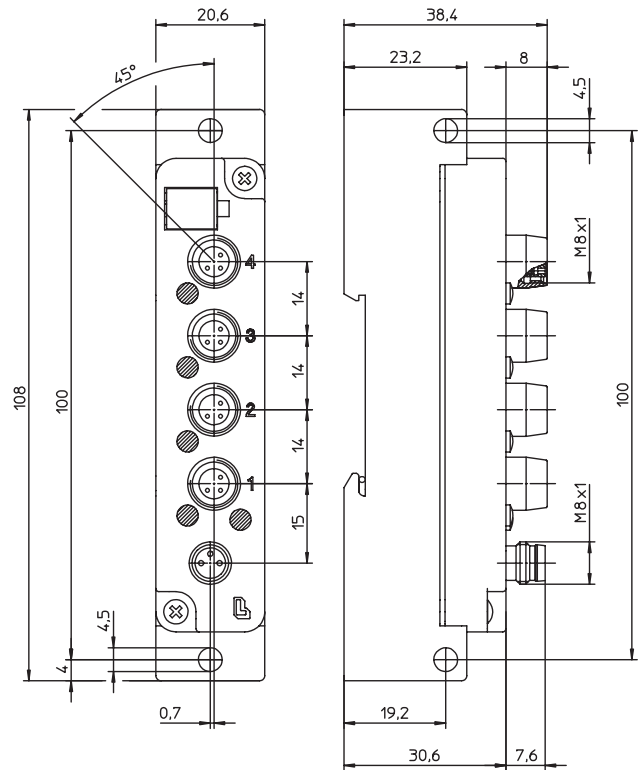

Bit Assignment								
Bit	-	-	-	-	3	2	1	0
M12 Input								
Byte 0	-	-	-	-	I-4	I-3	I-2	I-1

## Diagnostic Indication

LED	Indication	Condition
1...4	yellow	channel status
	green	slave is involved in data transfer
AS-i Dia	red	communications error no data transfer
	red flashing	periphery error (e.g. sensor supply overload or short circuit)

## Pin Assignment

### Bus Connection Pico (M8)

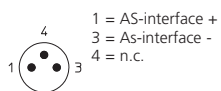

### Input Pico (M8)

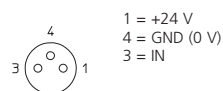



<b>Technical data</b>	
Degree of protection	IP 67
Operating temperature range	-15°C (+5°F) / +60°C (+140°F)
Weight	100 g
Housing	PUR
<b>Bus system</b>	
AS-Interface profile	S 0.A.E
I/O configuration	0 hex
ID code	A hex
ID2 code (extended ID-code)	E hex
Support A/B addressing	yes
<b>AS-Interface Version 2.1</b>	
<b>Electronics power supply</b>	
Rated Voltage	AS-Interface network
Voltage Range	26.5 - 31.6 V DC
Power Consumption	max. 120 mA
Reverse Polarity Protection	yes
Indication	LED, green
<b>Input power supply</b>	
Voltage Range (AS-Interface net)	17-30 V
Total current of all sensors	max. 100 mA
Short circuit-proof	yes
<b>Inputs</b>	
Rated Input Voltage	24 V DC
Signal state "1"	Us > 11 V / Is > 6 mA
Signal state "0"	Is < 2 mA
Input current at 24 V	15 mA
Input circuit	PNP
Number of digital channels	4
Channel status indicator	LED, yellow per channel
<b>Diagnostic</b>	
Indication	LED, red
<b>Connecting information</b>	
M8 / M8	RSMV-RKMV (please reference Industrial Automation Interconnect Guide)

Part Number

0910 ASL 501



**0910 ASL 409**

Version 2.1 - 4 In

AS-Interface module with 4 digital inputs (PNP) and flat cable bus connecton. Features: AS-i profile V2.1, A/B addressing, short circuit detection, protection degree IP67 / NEMA 6P, shock and vibration protected by using potting technology.

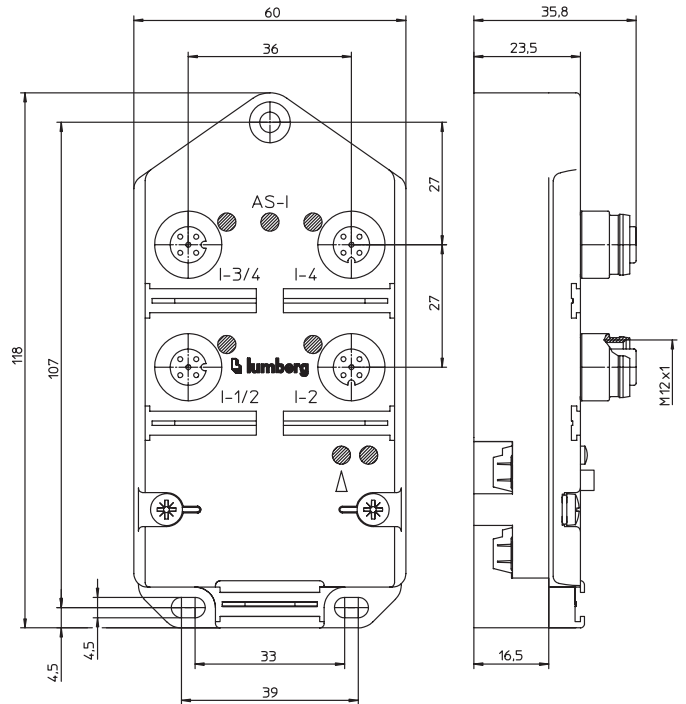

Bit Assignment								
Bit	-	-	-	-	3	2	1	0
M12 Input								
Byte 0	-	-	-	-	I-4	I-3/4	I-2	I-1/2

Diagnostic Indication		
LED	Indication	Condition
I-1...4	yellow	channel status
U-AS-i	green	AS-Interface power supply active
FID	red	communications error
	red flashing	periphery error (e.g. sensor/actuator short circuit)

### Pin Assignment

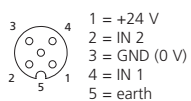
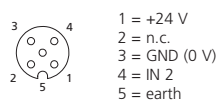
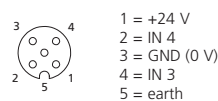
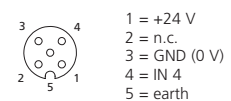
**Input 1 Micro (M12)**

**Input 2 Micro (M12)**

**Input 3 Micro (M12)**

**Input 4 Micro (M12)**



<b>Technical data</b>	
Degree of protection	IP 67
Operating temperature range	-25°C(+13°F) / +80°C (+158°F)
Weight	200 g
Housing	PUR
<b>Bus system</b>	
AS-Interface profile	S 0.A.E
I/O configuration	0 hex
ID code	A hex
ID2 code (extended ID-code)	E hex
Support A/B addressing	yes
<b>AS-Interface Version 2.1</b>	
<b>Electronics power supply</b>	
Rated voltage	AS-Interface network
Voltage range	26.5 - 31.6 V DC
Power consumption	max. 250 mA
Reverse polarity protection	yes
Indication	LED, green
<b>Input power supply</b>	
Voltage range (AS-Interface net)	17-30 V
Total current of all sensors	max. 200 mA
Short circuit-proof	yes
<b>Inputs</b>	
Rated input voltage	24 V DC
Signal state "1"	Us > 11 V / Is > 6 mA
Signal state "0"	Is < 2 mA
Input current at 24 V	15 mA
Input circuit	PNP
Number of digital channels	4
Channel status indicator	LED, yellow per channel
<b>Diagnostic</b>	
Indication	LED, red
<b>Note:</b>	
<p><i>The input channels are connected together in pairs, providing for greater connection flexibility (see pin assignment). In case of connection of a two-channel sensor to input socket 1 or 3 additional sensors must not be plugged to input socket 2 or 4 respectively due to the Y (cross) wiring of the inputs.</i></p>	

**Part Number**

0910 ASL 409



## 0910 ASL 132

4 In - M12

AS-Interface module with 4 digital inputs (PNP) and Micro (M12) bus connecton. Features: AS-i profile V2.0, short circuit detection, protection degree IP67 / NEMA 6P, shock and vibration protected by using potting technology.



replaces  
0910 ASL 112

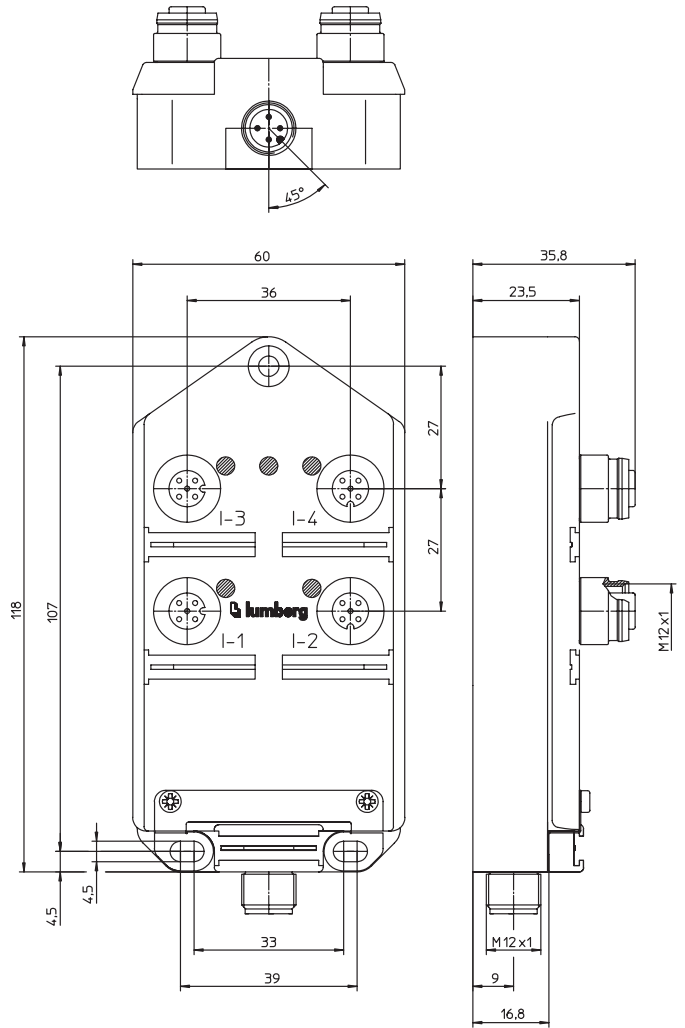

Bit Assignment								
Bit	-	-	-	-	3	2	1	0
M12 Input								
Byte 0	-	-	-	-	I-4	I-3	I-2	I-1

Diagnostic Indication		
LED	Indication	Condition
I-1...4	yellow	channel status
U-AS-i	green	AS-Interface power supply active

## Pin Assignment

### Bus Connection Micro (M12)

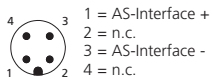

### Input Micro (M12)

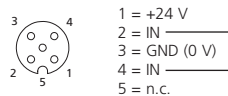

<b>Technical data</b>	
Degree of protection	IP 67
Operating temperature range	-25°C(+13°F) / +80°C (+158°)
Weight	200 g
Housing	PUR
<b>Bus system</b>	
AS-Interface profile	S 0.0.F
I/O configuration	0 hex
ID code	0 hex
ID2 code (extended ID-code)	F hex
Support A/B addressing	no
<b>Electronics power supply</b>	
Rated voltage	AS-Interface network
Voltage range	26.5 - 31.6 V DC
Power consumption	max. 250 mA
Reverse polarity protection	yes
Indication	LED, green
<b>Input Power Supply</b>	
Voltage range (AS-Interface net)	17-30 V
Total current of all sensors	max. 200 mA
Short circuit-proof	yes
<b>Inputs</b>	
Rated input voltage	24 V DC
Signal state "1"	Us > 11 V / Is > 6 mA
Signal state "0"	Is < 2 mA
Input current at 24 V	15 mA
Input circuit	PNP
Number of digital channels	4
Channel status indicator	LED, yellow per channel
<b>Diagnostic</b>	
Indication	LED, red
<b>Connecting information</b>	
M12 / M12	0915 034 101/...M

Part Number

0910 ASL 132



**0910 ASL 412** Version 2.1 - 8 In

AS-Interface module with 8 digital inputs (PNP) and flat cable bus connecton. Features: AS-i profile V2.1, protection degree IP67 / NEMA 6P, shock and vibration protected by using potting technology.

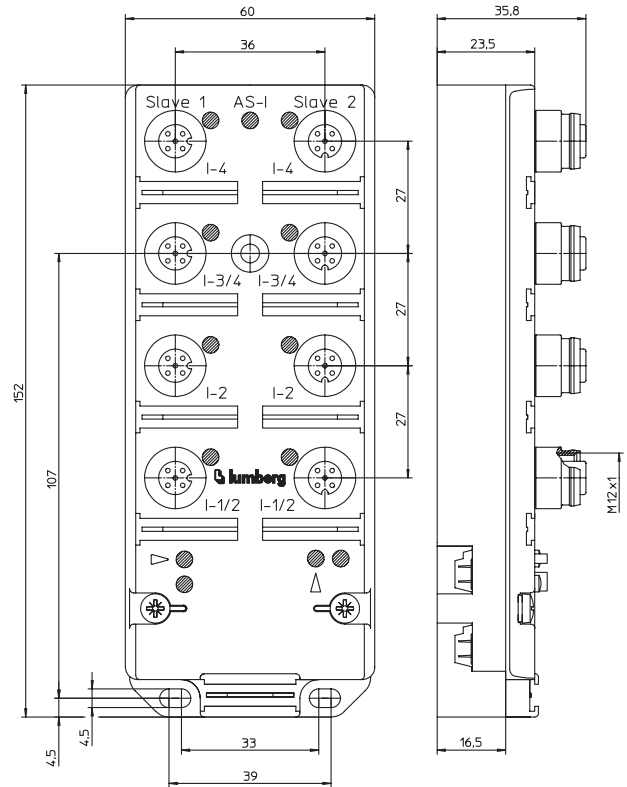

Bit Assignment								
Bit	-	-	-	-	3	2	1	0
M12 Input								
Byte 0 / Slave 1	-	-	-	-	I-4	I-3	I-2	I-1
Byte 1 / Slave 2	-	-	-	-	I-4	I-3	I-2	I-1

Diagnostic Indication		
LED	Indication	Condition
I-1...4	yellow	channel status
U-AS-i	green	AS-Interface power supply active
FID	red	communications error
	red flashing	periphery error (e.g. sensor/actuator short circuit)

**Pin Assignment (per slave)**

**Input 1 Micro (M12)**

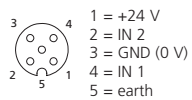

**Input 2 Micro (M12)**

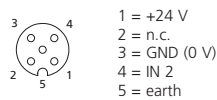

**Input 3 Micro (M12)**

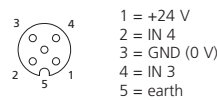

**Input 4 Micro (M12)**

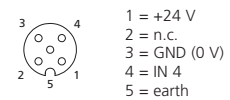



<b>Technical data</b>	
Degree of protection	IP 67
Operating temperature range	-25°C(+13°F) / +80°C (+158°)
Weight	300 g
Housing	PUR
<b>Bus system</b>	
AS-Interface profile	S 0.I.E
I/O configuration	0 hex
ID code	1 hex
ID2 code (extended ID-code)	E hex
Support A/B addressing	yes
<b>AS-Interface Version 2.1</b>	
<b>Electronics power supply</b>	
Rated voltage	AS-Interface network
Voltage range	26.5 - 31.6 V DC
Power consumption	max. 500 mA
Reverse polarity protection	yes
Indication	LED, green
<b>Input power supply</b>	
Voltage range (AS-Interface net)	17-30 V
Total current of all sensors	max. 200 mA
Short circuit-proof	yes
<b>Inputs</b>	
Rated input voltage	24 V DC
Signal state "1"	Us > 11 V / Is > 6 mA
Signal state "0"	Is < 2 mA
Input current at 24 V	15 mA
Input circuit	PNP
Number of digital channels	8
Channel status indicator	LED, yellow per channel
<b>Diagnostic</b>	
Indication	LED, red
<b>Note:</b>	
<p><i>The input channels are connected together in pairs, providing for greater connection flexibility (see pin assignment). In case of connection of a two-channel sensor to input socket 1 or 3 additional sensors must not be plugged to input socket 2 or 4 respectively due to the Y (cross) wiring of the inputs.</i></p>	

**Part Number**

0910 ASL 412



**0910 ASL 403**

4 Out

AS-Interface module with 4 digital outputs (2A) and flat cable bus connecton. Features: AS-i profile V2.0, short circuit protection, protection degree IP67 / NEMA 6P, shock and vibration protected by using potting technology.

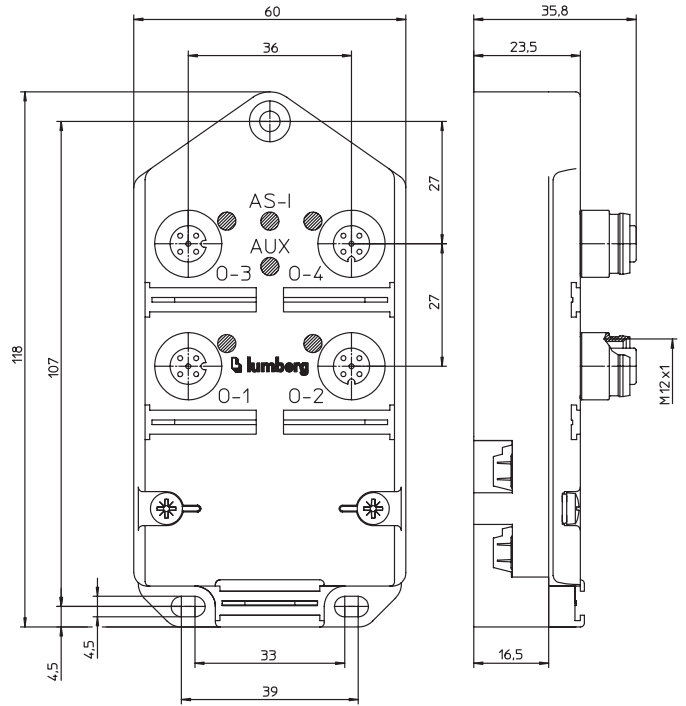

Bit Assignment								
Bit	-	-	-	-	3	2	1	0
M12 Output								
Byte 0	-	-	-	-	O-4	O-3	O-2	O-1

Diagnostic Indication		
LED	Indication	Condition
O-1...4	yellow	channel status
U-AS-i	green	AS-Interface power supply active
AUX	green	actuator supply active

**Pin Assignment**

**Output Micro (M12)**

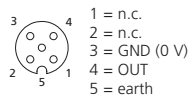



<b>Technical data</b>	
Degree of protection	IP 67
Operating temperature range	-25°C(+13°F) / +80°C (+158°)
Weight	200 g
Housing	PUR
<b>Bus system</b>	
AS-Interface profile	8.0
I/O configuration	8 hex
ID code	0 hex
Support A/B addressing	no
<b>Electronics power supply</b>	
Rated voltage	AS-Interface network
Voltage range	26.5 - 31.6 V DC
Power consumption	max. 75 mA
Reverse polarity protection	yes
Indication	LED, green
<b>Output power supply</b>	
Voltage range (AS-Interface net)	24 V DC
Voltage range	10-30 V
Potential separation	present
Reverse polarity protection	yes/electronic
Indication	LED, green
<b>Outputs</b>	
Rated output voltage	2 A per channel
Short circuit-proof	yes
Max. output current	4 A per module
Overload-proof	yes
Number of digital channels	4
Channel type N.O.	PNP
Channel status indicator	LED, yellow per channel
<b>AS-Interface Version 2.0</b>	
<b>AS-Interface</b>	
<b>AUX</b>	
<b>Type 2 Acc. to IEC 61131-2</b>	

**Part Number**

0910 ASL 403



**0910 ASL 133** 4 Out - M12

AS-Interface module with 4 digital outputs (2A) and Micro (M12) bus connector. Features: AS-i profile V2.0, short circuit protection, protection degree IP67 / NEMA 6P, shock and vibration protected by using potting technology.



replaces  
0910 ASL 111

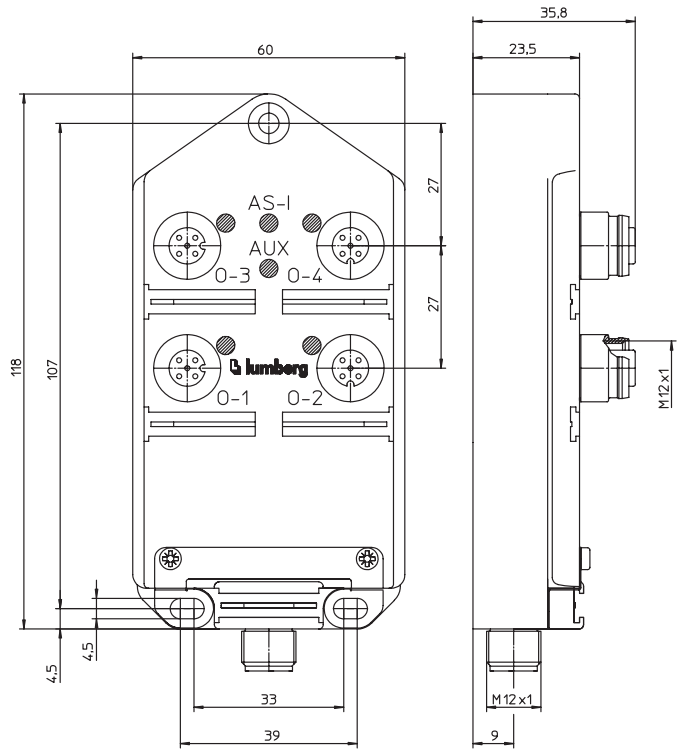

Bit Assignment								
Bit	-	-	-	-	3	2	1	0
M12 Output								
Byte 0	-	-	-	-	O-4	O-3	O-2	O-1

Diagnostic Indication		
LED	Indication	Condition
O-1...4	yellow	channel status
U-AS-i	green	AS-Interface power supply active
AUX	green	actuator supply active

**Pin Assignment**

**Bus Connection Micro (M12)**

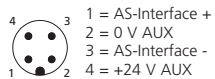

**Output Micro (M12)**

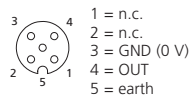



<b>Technical data</b>	
Degree of protection	IP 67
Operating temperature range	-25°C(+13°F) / +80°C (+158°)
Weight	200 g
Housing	PUR
<b>Bus System</b>	
AS-Interface profile	S 8.0.F
I/O configuration	8 hex
ID code	0 hex
ID2 code (extended ID-code)	F hex
Support A/B addressing	no
<b>Electronics power supply</b>	
Rated voltage	AS-Interface network
Voltage range	26.5 - 31.6 V DC
Power consumption	max. 75 mA
Reverse polarity protection	yes
Indication	LED, green
<b>Output power supply</b>	
Voltage range (AS-Interface net)	24 V DC
Voltage range	10-30 V
Potential separation	present
Reverse polarity protection	yes/electronic
Indication	LED, green
<b>Outputs</b>	
Rated output voltage	2 A per channel
Short circuit-proof	yes
Max. output current	4 A per module
Overload-proof	yes
Number of digital channels	4
Channel type N.O.	PNP
Channel status indicator	LED, yellow per channel
<b>Diagnosis</b>	
Indication	LED, red
<b>Connecting information</b>	
M12 / M12	0915 034 101/...M

**Part Number**

0910 ASL 133



**0910 ASL 419** Version 2.1 - 8 Out

AS-Interface module with 8 digital outputs (0.5A) and flat cable bus connecton. Features: AS-i profile V2.1, short circuit protection, protection degree IP67 / NEMA 6P, shock and vibration protected by using potting technology.

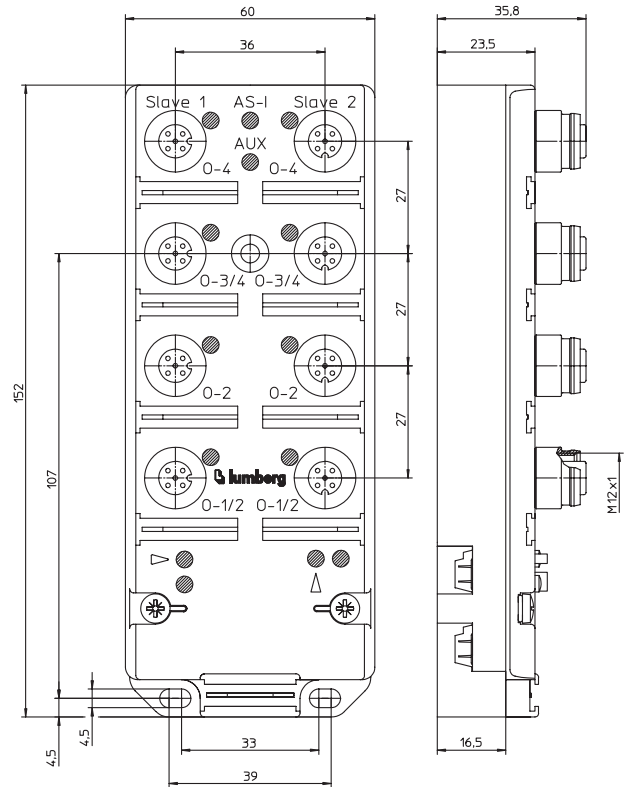

Bit Assignment								
Bit	-	-	-	-	3	2	1	0
M12 Input								
Byte 0 / Slave 1	-	-	-	-	O-4	O-3	O-2	O-1
Byte 1 / Slave 2	-	-	-	-	O-4	O-3	O-2	O-1

Diagnostic Indication		
LED	Indication	Condition
O-1...4	yellow	channel status
AS-i	green	AS-Interface power supply active
AUX	green	actuator supply active
FID	red	communications error
	red flashing	periphery error (actuator short circuit)

**Pin Assignment (per slave)**

**Output 1 Micro (M12)**

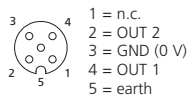

- 1 = n.c.
- 2 = OUT 2
- 3 = GND (0 V)
- 4 = OUT 1
- 5 = earth

**Input 2 Micro (M12)**



- 1 = n.c.
- 2 = n.c.
- 3 = GND (0 V)
- 4 = OUT 2
- 5 = earth

**Input 3 Micro (M12)**



- 1 = n.c.
- 2 = OUT 4
- 3 = GND (0 V)
- 4 = OUT 3
- 5 = earth

**Input 4 Micro (M12)**



- 1 = n.c.
- 2 = n.c.
- 3 = GND (0 V)
- 4 = OUT 4
- 5 = earth



<b>Technical data</b>	
Degree of protection	IP 67
Operating temperature range	-25°C(+13°F) / +80°C (+158°)
Weight	300 g
Housing	PUR
<b>Bus system</b>	
AS-Interface profile	S 8.1.E
I/O configuration	8 hex
ID code	1 hex
ID2 code (extended ID-code)	E hex
Support A/B addressing	no
<b>AS-Interface Version 2.1</b>	
<b>Electronics power supply</b>	
Rated voltage	AS-Interface network
Voltage range	26.5 - 31.6 V DC
Power consumption	max. 75 mA
Reverse polarity protection	yes
Indication	LED, green
<b>AUX</b>	
Rated voltage	24 V DC
Voltage range	10-30 V
Potential separation	present
Reverse polarity protection	yes/electronic
Indication	LED, green
<b>AS-Interface</b>	
<b>Output power supply</b>	
Rated output voltage	0.5 A per channel
Short circuit-proof	yes
Max. output current	4 A per module
Overload-proof	yes
Number of digital channels	8
Channel type N.O.	PNP
Channel status indicator	LED, yellow per channel
<b>Type 2 Acc. to IEC 61131-2</b>	
<b>Diagnostic</b>	
Indication	LED, red
<b>Note:</b>	
<i>The output channels are connected together providing for a greater connection flexibility (see pin assignment). When actuators are connected, this Y (cross) wiring of the terminal sockets has to be taken into consideration with respect to current load.</i>	

**Part Number**

0910 ASL 419



**0910 ASL 410**

Version 2.1 - 2 In / 2 Out

AS-Interface module with 2 digital inputs (PNP), 2 digital outputs (2A) and flat cable bus connector. Features: AS-i profile V2.1, short circuit detection, protection degree IP67 / NEMA 6P, shock and vibration protected by using potting technology.

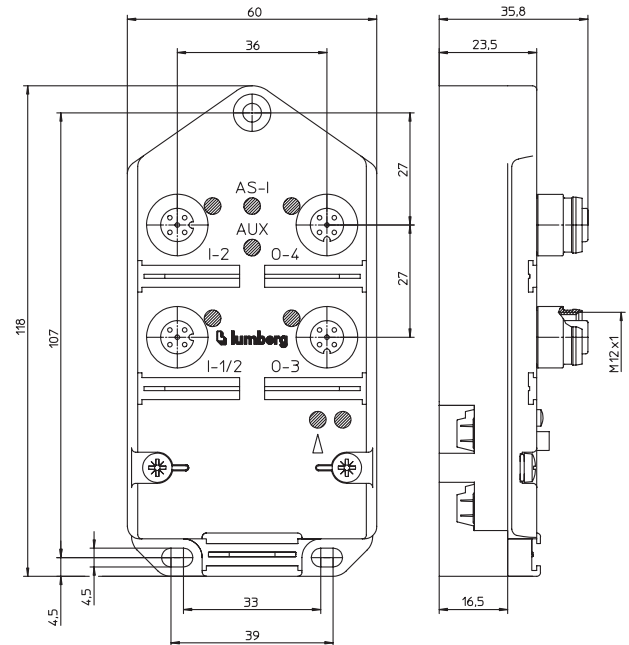

Bit Assignment									
Bit	-	-	-	-	3	2	1	0	
M12 Input									
Byte 0	-	-	-	-	-	-	I-2	I-1/2	
M12 Output									
Byte 0	-	-	-	-	O-4	O-3	-	-	

Diagnostic Indication		
LED	Indication	Condition
I-1...2 / O-3...4	yellow	channel status
U-AS-i	green	AS-Interface power supply active
AUX	green	actuator supply active
FID	red	communications error
	red flashing	periphery error (sensor/actuator short circuit)

### Pin Assignment

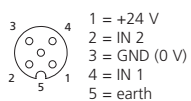
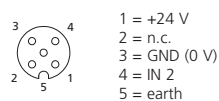
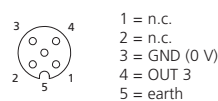
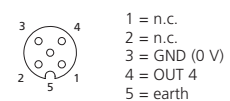
**Input 1 Micro (M12)**

**Input 2 Micro (M12)**

**Output 3 Micro (M12)**

**Output 4 Micro (M12)**



**Technical data**

Degree of protection	IP 67
Operating temperature range	-25°C(+13°F) / +80°C (+158°)
Weight	200 g
Housing	PUR

**Bus system**

AS-Interface profile	<b>AS-Interface Version 2.1</b> S 3.F.E
I/O configuration	3 hex
ID code	F hex
ID2 code (extended ID-code)	E hex
Support A/B addressing	no

**Electronics power supply**

Rated voltage	<b>AS-Interface</b> AS-Interface network
Voltage range	26.5 - 31.6 V DC
Power consumption	max. 250 A
Reverse polarity protection	yes
Indication	LED, green

**Input power supply**

Voltage range (AS-Interface net)	17-30 V
Total current of all sensors	max. 200 mA
Short circuit-proof	yes

**Inputs**

Rated input voltage	<b>Type 2 Acc. to IEC 61131-2</b> 24 V DC
Signal state "1"	Us > 11 V / Is > 6 mA
Signal state "0"	Is < 2 mA
Input current at 24 V	15 mA
Input circuit	PNP
Number of digital channels	2
Channel status indicator	LED, yellow per channel

**Output power supply**

Voltage range (AS-Interface net)	<b>AUX</b> 24 V DC
Voltage range	10-30 V
Potential separation	present
Reverse polarity protection	yes/electronic
Indication	LED, green

**Outputs**

Rated output voltage	<b>Type 2 Acc. to IEC 61131-2</b> 2 A per channel
Short circuit-proof	yes
Max. output current	4 A per module
Overload-proof	yes
Number of digital channels	2
Channel type N.O.	PNP
Channel status indicator	LED, yellow per channel

**Diagnostic**

Indication	LED, red
------------	----------

**Note:**

*The input channels are connected together providing for a greater connection flexibility (see pin assignment). In cases when a connection of a two-channel sensor to input socket 1 is required, no other sensors should be plugged into socket 2 due to the Y (cross) wiring of the inputs.*

**Part Number**

0910 ASL 410



**0910 ASL 134** 2 In / 2 Out - M12

AS-Interface module with 2 digital inputs (PNP), 2 digital outputs (2A) and Micro (M12) bus connecton. Features: AS-i profile V2.0, short circuit detection, protection degree IP67 / NEMA 6P, shock and vibration protected by using potting technology.



replaces  
0910 ASL 110

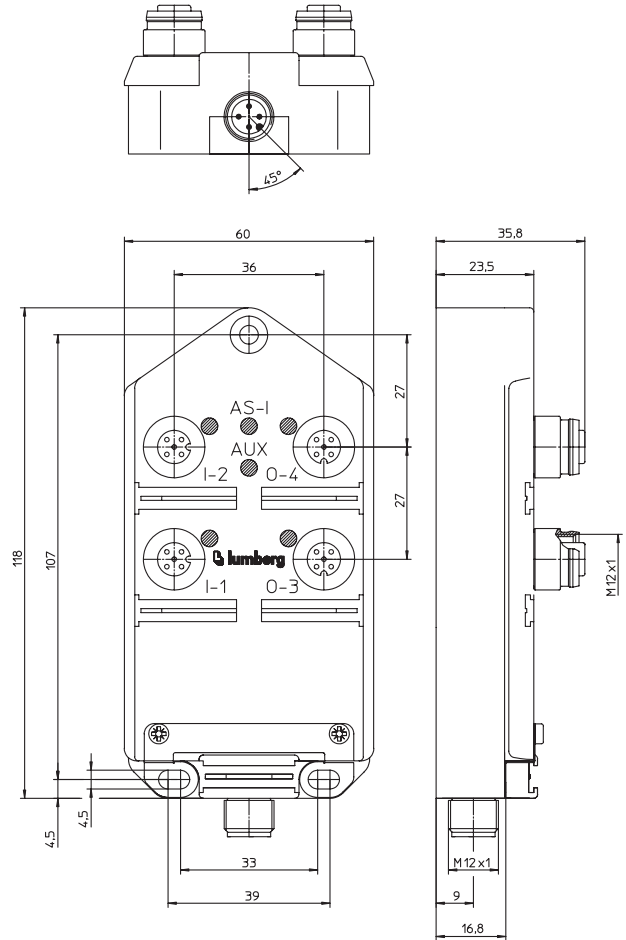

Bit Assignment									
Bit	-	-	-	-	3	2	1	0	
M12 Input									
Byte 0	-	-	-	-	-	-	I-2	I-1	
M12 Output									
Byte 0	-	-	-	-	O-4	O-3	-	-	

Diagnostic Indication		
LED	Indication	Condition
I-1...2 / O-3...4	yellow	channel status
U-AS-i	green	AS-Interface power supply active
AUX	green	actuator supply active

**Pin Assignment**

**Bus Connection Micro (M12)**

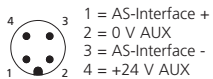

**Input Micro (M12)**

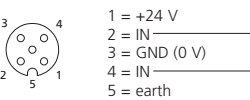

**Output Micro (M12)**

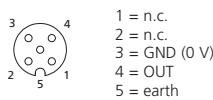

**Technical data**

Degree of protection	IP 67
Operating temperature range	-25°C(+13°F) / +80°C (+158°)
Weight	200 g
Housing	PUR

**Bus system**

AS-Interface profile	<b>AS-Interface Version 2.0</b>
I/O configuration	S 3.0.F
ID code	3 hex
ID2 code (extended ID-code)	0 hex
Support A/B addressing	F hex
	no

**Electronics power supply**

Rated voltage	<b>AS-Interface</b>
Voltage range	AS-Interface network
Power consumption	26.5 - 31.6 V DC
Reverse polarity protection	max. 250 mA
Indication	yes
	LED, green

**Input power supply**

Voltage range (AS-Interface net)	17-30 V
Total current of all sensors	max. 200 mA
Short circuit-proof	yes

**Inputs**

Rated Input Voltage	<b>Type 2 Acc. to IEC 61131-2</b>
Signal state "1"	24 V DC
Signal state "0"	Us > 11 V / Is > 6 mA
Input current at 24 V	Is < 2 mA
Input circuit	15 mA
Number of digital channels	PNP
Channel status indicator	2
	LED, yellow per channel

**Output Power Supply**

Voltage Range (AS-Interface net)	<b>AUX</b>
Voltage range	24 V DC
Potential separation	10-30 V
Reverse polarity protection	present
Indication	yes/electronic
	LED, green

**Outputs**

Rated output voltage	<b>Type 2 Acc. to IEC 61131-2</b>
Short circuit-proof	2 A per channel
Max. output current	yes
Overload-proof	4 A per module
Number of digital channels	yes
Channel type N.O.	2
Channel status indicator	PNP
	LED, yellow per channel

**Diagnostic**

Indication	LED, red
------------	----------

**Part Number**

0910 ASL 134



**0910 ASL 414** Version 2.1 - 4 In / 3 Out

AS-Interface module with 4 digital inputs (PNP), 3 digital outputs (2A) and flat cable bus connector. Features: AS-i profile V2.1, A/B addressing, short circuit detection, protection degree IP67 / NEMA 6P, shock and vibration protected by using potting technology.

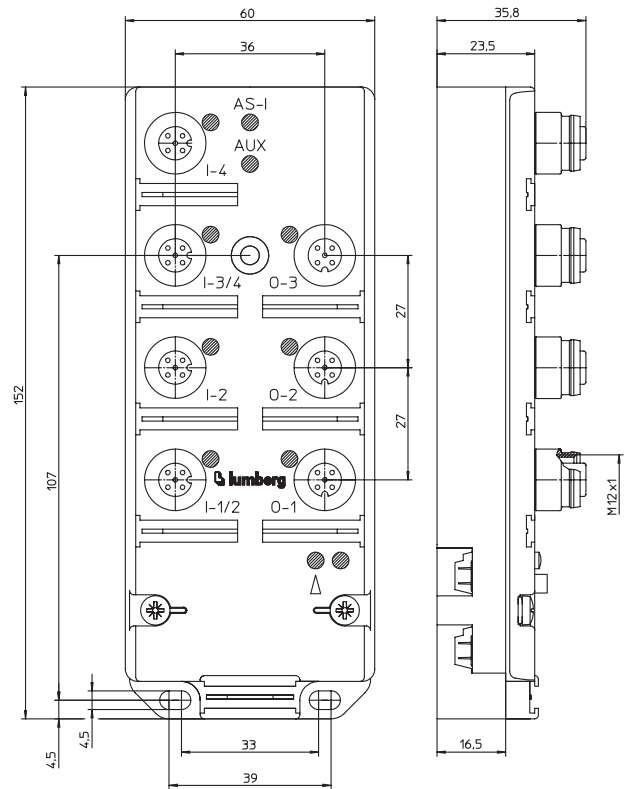

Bit Assignment								
Bit	-	-	-	-	3	2	1	0
<b>M12 Input</b>								
Byte 0	-	-	-	-	I-4	I-3/4	I-2	I-1/2
<b>M12 Output</b>								
Byte 0	-	-	-	-	-	O-3	O-2	O-1

Diagnostic Indication		
LED	Indication	Condition
I-1...4 / O-1...3	yellow	channel status
AS-i	green	AS-Interface power supply active
AUX	green	actuator supply active
FID	red	communications error
	red flashing	periphery error (actuator short circuit/ sensor supply error)

## Pin Assignment

### Input 1 Micro (M12)

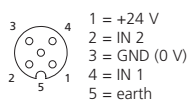

### Input 2 Micro (M12)

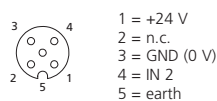

### Input 3 Micro (M12)

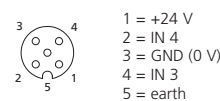

### Input 4 Micro (M12)

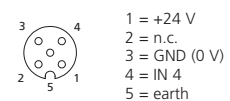

### Output 1 Micro (M12)

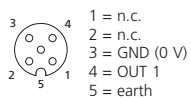

### Output 2 Micro (M12)

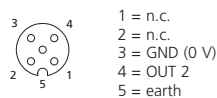

### Output 3 Micro (M12)

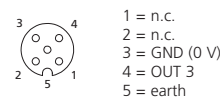

**Technical data**

Degree of protection	IP 67
Operating temperature range	-25°C(+13°F) / +80°C (+158°)
Weight	300 g
Housing	PUR

**Bus system**

AS-Interface profile	<b>AS-Interface Version 2.1</b>
I/O configuration	S 7.A.E
ID code	7 hex
ID2 code (extended ID-code)	A hex
Support A/B addressing	E hex
	yes

**Electronics power supply**

Rated voltage	<b>AS-Interface</b>
Voltage range	AS-Interface network
Power consumption	26.5 - 31.6 V DC
Reverse polarity protection	max. 100 mA
Indication	yes
	LED, green

**Input power supply**

Voltage range (AS-Interface net)	17-30 V
Total current of all sensors	max. 100 mA
Short circuit-proof	yes

**Inputs**

Rated Input Voltage	<b>Type 2 Acc. to IEC 61131-2</b>
Signal state "1"	24 V DC
Signal state "0"	Us > 11 V / Is > 4.7 mA
Input current at 24 V	Is < 1.5 mA
Input circuit	15 mA
Number of digital channels	PNP
Channel status indicator	4
	LED, yellow per channel

**Output power supply**

Voltage range (AS-Interface net)	<b>AUX</b>
Voltage range	24 V DC
Potential separation	10-30 V
Reverse polarity protection	present
Indication	yes/electronic
	LED, green

**Outputs**

Rated output voltage	<b>Type 2 Acc. to IEC 61131-2</b>
Short circuit-proof	2 A per channel
Max. output current	yes
Overload-proof	4 A per module
Number of digital channels	yes
Channel type N.O.	3
Channel status indicator	PNP
	LED, yellow per channel

**Diagnostic**

Indication	LED, red
------------	----------

**Note:**

*The input channels are connected together providing for a greater connection flexibility (see pin assignment). In case of connection of a two-channel sensor to input socket 1 or 3 additional sensors must not be plugged into the input socket 2 or 4 respectively due to the Y (cross) wiring of the inputs.*

**Part Number**

0910 ASL 414



## 0910 ASL 408

Version 2.1 - 4 In / 4 Out

AS-Interface module with 4 digital inputs (PNP), 4 digital outputs (2A) and flat cable bus connector. Features: AS-i profile V2.1, short circuit detection, protection degree IP67 / NEMA 6P, shock and vibration protected by using potting technology.

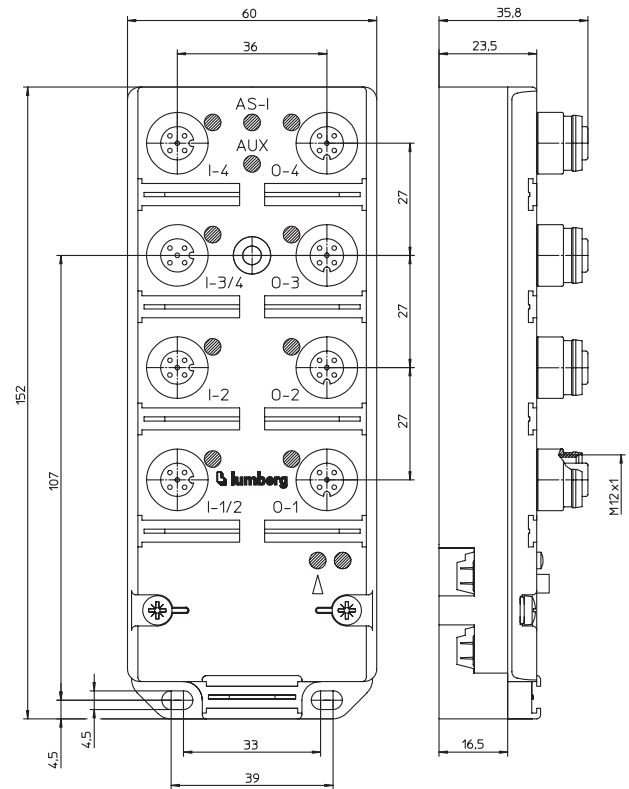

Bit Assignment								
Bit	-	-	-	-	3	2	1	0
<b>M12 Input</b>								
Byte 0	-	-	-	-	I-4	I-3/4	I-2	I-1/2
<b>M12 Output</b>								
Byte 0	-	-	-	-	O-4	O-3	O-2	O-1

Diagnostic Indication		
LED	Indication	Condition
I-1...4 / O-1...3	yellow	channel status
AS-i	green	AS-Interface power supply active
AUX	green	actuator supply active
	red	communications error
FID	red flashing	periphery error (sensor/actuator circuit)

Pin Assignment			
<b>Input 1 Micro (M12)</b> <ul style="list-style-type: none"> <li>1 = +24 V</li> <li>2 = IN 2</li> <li>3 = GND (0 V)</li> <li>4 = IN 1</li> <li>5 = earth</li> </ul>	<b>Input 2 Micro (M12)</b> <ul style="list-style-type: none"> <li>1 = +24 V</li> <li>2 = n.c.</li> <li>3 = GND (0 V)</li> <li>4 = IN 2</li> <li>5 = earth</li> </ul>	<b>Input 3 Micro (M12)</b> <ul style="list-style-type: none"> <li>1 = +24 V</li> <li>2 = IN 4</li> <li>3 = GND (0 V)</li> <li>4 = IN 3</li> <li>5 = earth</li> </ul>	<b>Input 4 Micro (M12)</b> <ul style="list-style-type: none"> <li>1 = +24 V</li> <li>2 = n.c.</li> <li>3 = GND (0 V)</li> <li>4 = IN 4</li> <li>5 = earth</li> </ul>
<b>Output 1 Micro (M12)</b> <ul style="list-style-type: none"> <li>1 = n.c.</li> <li>2 = n.c.</li> <li>3 = GND (0 V)</li> <li>4 = OUT 1</li> <li>5 = earth</li> </ul>	<b>Output 2 Micro (M12)</b> <ul style="list-style-type: none"> <li>1 = n.c.</li> <li>2 = n.c.</li> <li>3 = GND (0 V)</li> <li>4 = OUT 2</li> <li>5 = earth</li> </ul>	<b>Output 3 Micro (M12)</b> <ul style="list-style-type: none"> <li>1 = n.c.</li> <li>2 = n.c.</li> <li>3 = GND (0 V)</li> <li>4 = OUT 3</li> <li>5 = earth</li> </ul>	<b>Output 4 Micro (M12)</b> <ul style="list-style-type: none"> <li>1 = n.c.</li> <li>2 = n.c.</li> <li>3 = GND (0 V)</li> <li>4 = OUT 4</li> <li>5 = earth</li> </ul>

**Technical data**

Degree of protection	IP 67
Operating temperature range	-25°C(+13°F) / +80°C (+158°)
Weight	300 g
Housing	PUR

**Bus system**

AS-Interface profile	<b>AS-Interface Version 2.1</b>
I/O configuration	S 7.F.E
ID code	7 hex
ID2 code (extended ID-code)	F hex
Support A/B addressing	E hex
	no

**Electronics power supply**

Rated voltage	<b>AS-Interface</b>
Voltage range	AS-Interface network
Power consumption	26.5 - 31.6 V DC
Reverse polarity protection	max. 250 mA
Indication	yes
	LED, green

**Input power supply**

Voltage range (AS-Interface net)	17-30 V
Total current of all sensors	max. 200 mA
Short circuit-proof	yes

**Inputs**

Rated Input Voltage	<b>Type 2 Acc. to IEC 61131-2</b>
Signal state "1"	24 V DC
Signal state "0"	Us > 11 V / Is > 6 mA
Input current at 24 V	Is < 2 mA
Input circuit	15 mA
Number of digital channels	PNP
Channel status indicator	4
	LED, yellow per channel

**Output power supply**

Voltage range (AS-Interface net)	<b>AUX</b>
Voltage range	24 V DC
Potential separation	10-30 V
Reverse polarity protection	present
Indication	yes/electronic
	LED, green

**Outputs**

Rated output voltage	<b>Type 2 Acc. to IEC 61131-2</b>
Short circuit-proof	2 A per channel
Max. output current	yes
Overload-proof	4 A per module
Number of digital channels	yes
Channel type N.O.	4
Channel status indicator	PNP
	LED, yellow per channel

**Diagnostic**

Indication	LED, red
------------	----------

**Note:**

*The input channels are connected together providing for a greater connection flexibility (see pin assignment). In case of connection of a two-channel sensor to input socket 1 or 3 additional sensors must not be plugged into the input socket 2 or 4 respectively due to the Y (cross) wiring of the inputs.*

**Part Number**

0910 ASL 408



**0910 ASL 135** 4 In / 4 Out - M12

AS-Interface module with 4 digital inputs (PNP), 4 digital outputs (2A) and Micro (M12) bus connecton. Features: AS-i profile V2.0, short circuit detection, protection degree IP67 / NEMA 6P, shock and vibration protected by using potting technology.



replaces  
0910 ASL 109

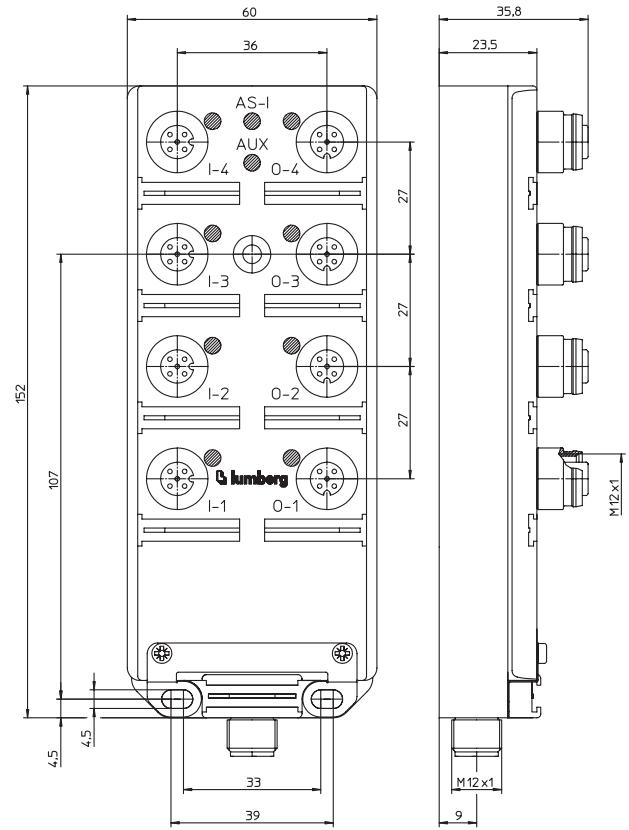

Bit Assignment								
Bit	-	-	-	-	3	2	1	0
<b>M12 Input</b>								
Byte 0	-	-	-	-	I-4	I-3	I-2	I-1
<b>M12 Output</b>								
Byte 0	-	-	-	-	O-4	O-3	O-2	O-1

Diagnostic Indication		
LED	Indication	Condition
I-1...2 / O-3...4	yellow	channel status
U-AS-i	green	AS-Interface power supply active
AUX	green	actuator supply active

**Pin Assignment**

**Bus Connection Micro (M12)**

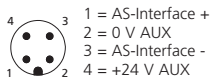

**Input Micro (M12)**

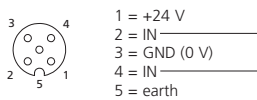

**Output Micro (M12)**

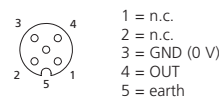



<p><b>Technical data</b></p> <p>Degree of protection IP 67          Operating temperature range -25°C(+13°F) / +80°C (+158°)          Weight 200 g          Housing PUR</p>		<p><b>Output power supply</b></p> <p>Voltage range (AS-Interface net) 24 V DC          Voltage range 10-30 V          Potential separation present          Reverse polarity protection yes/electronic          Indication LED, green</p>	
<p><b>Bus System</b></p> <p>AS-Interface profile S 7.0.F          I/O configuration 7 hex          ID code 0 hex          ID2 code (extended ID-code) F hex          Support A/B addressing no</p>		<p><b>AUX</b></p> <p><b>Type 2 Acc. to IEC 61131-2</b></p> <p>2 A per channel          yes          4 A per module          yes          4          PNP          LED, yellow per channel</p>	
<p><b>Electronics power supply</b></p> <p>Rated voltage AS-Interface          Voltage range AS-Interface network 26.5 - 31.6 V DC          Power consumption max. 250 mA          Reverse polarity protection yes          Indication LED, green</p>		<p><b>Outputs</b></p> <p>Rated output voltage 2 A per channel          Short circuit-proof yes          Max. output current 4 A per module          Overload-proof yes          Number of digital channels 4          Channel type N.O. PNP          Channel status indicator LED, yellow per channel</p>	
<p><b>Input power supply</b></p> <p>Voltage range (AS-Interface net) 17-30 V          Total current of all sensors max. 200 mA          Short circuit-proof yes</p>		<p><b>Diagnostic</b></p> <p>Indication LED, red</p>	
<p><b>Inputs</b></p> <p>Rated Input Voltage 24 V DC          Signal state "1" <math>U_s &gt; 11\text{ V} / I_s &gt; 6\text{ mA}</math>          Signal state "0" <math>I_s &lt; 2\text{ mA}</math>          Input current at 24 V 15 mA          Input circuit PNP          Number of digital channels 4          Channel status indicator LED, yellow per channel</p>		<p><b>Connecting information</b></p> <p>M12 / M12 0915 034 101/...M</p>	

## 0910 ASL 424

Version 2.1 - 4 In / 4 Out

AS-Interface module with 4 digital inputs (PNP), 4 digital outputs (2A), Y-wiring scheme, and Micro (M12) bus connecton. Features: Stainless steel housing for food & beverage industry applications AS-i profile V2.1, short circuit detection, protection degree IP 69K, shock and vibration protected by using potting technology.

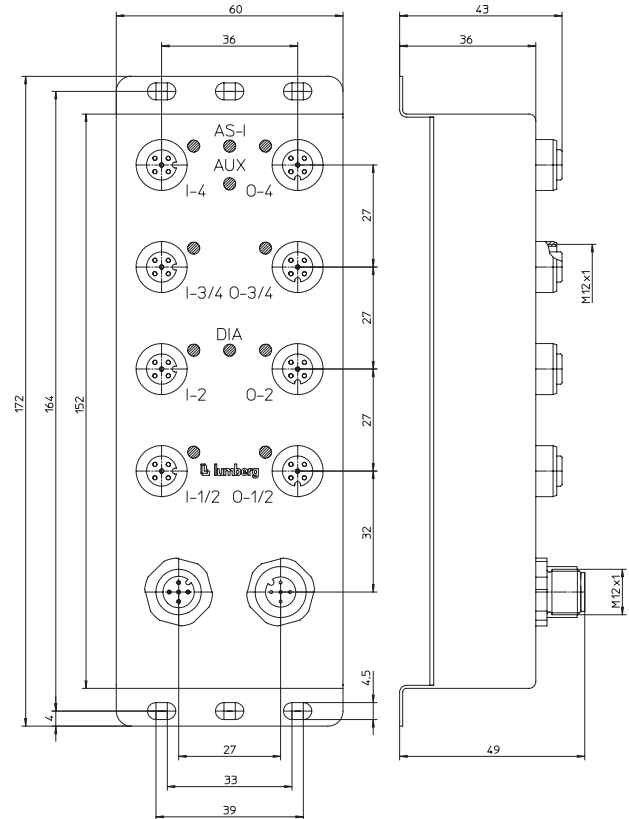

Bit Assignment								
Bit	-	-	-	-	3	2	1	0
<b>M12 Input</b>								
Byte 0	-	-	-	-	I-4	I-3/4	I-2	I-1/2
<b>M12 Output</b>								
Byte 0	-	-	-	-	O-4	O-3/4	O-2	O-1/2

Diagnostic Indication		
LED	Indication	Condition
I-1...4 / O-1...3	yellow	channel status
AS-i	green	AS-Interface power supply active
AUX	green	actuator supply active
DIA	red	communications error / address at 0
	red flashing	periphery error (actuator short circuit/sensor supply error)

Pin Assignment			
<b>Input 1 Micro (M12)</b>  1 = +24 V 2 = IN 2 3 = GND (0 V) 4 = IN 1 5 = earth	<b>Input 2 Micro (M12)</b>  1 = +24 V 2 = n.c. 3 = GND (0 V) 4 = IN 2 5 = earth	<b>Input 3 Micro (M12)</b>  1 = +24 V 2 = IN 4 3 = GND (0 V) 4 = IN 3 5 = earth	<b>Input 4 Micro (M12)</b>  1 = +24 V 2 = n.c. 3 = GND (0 V) 4 = IN 4 5 = earth
<b>Output 1 Micro (M12)</b>  1 = n.c. 2 = OUT 2 3 = GND (0 V) 4 = OUT 1 5 = earth	<b>Output 2 Micro (M12)</b>  1 = n.c. 2 = n.c. 3 = GND (0 V) 4 = OUT 2 5 = earth	<b>Output 3 Micro (M12)</b>  1 = n.c. 2 = OUT 4 3 = GND (0 V) 4 = OUT 3 5 = earth	<b>Output 4 Micro (M12)</b>  1 = n.c. 2 = n.c. 3 = GND (0 V) 4 = OUT 4 5 = earth

**Technical data**

Degree of protection	IP 69K
Operating temperature range	-25°C(+13°F) / +80°C (+158°)
Weight	550 g
Housing	Stainless Steel

**Bus system**

AS-Interface profile	<b>AS-Interface Version 2.1</b>
I/O configuration	S 7.F.E
ID code	7 hex
ID2 code (extended ID-code)	F hex
Support A/B addressing	E hex
	no

**Electronics power supply**

Rated voltage	<b>AS-Interface</b>
Voltage range	AS-Interface network
Power consumption	26.5 - 31.6 V DC
Reverse polarity protection	max. 310 mA
Indication	yes
	LED, green

**Input power supply**

Voltage range (AS-Interface net)	17-30 V
Total current of all sensors	max. 200 mA
Short circuit-proof	yes

**Inputs**

Rated input voltage	<b>Type 2 Acc. to IEC 61131-2</b>
Signal state "1"	24 V DC
Signal state "0"	Us > 10 V / Is > 4.7 mA
Input current at 24 V	Is < 1.5 mA
Input circuit	15 mA
Number of digital channels	PNP
Channel status indicator	4
	LED, yellow per channel

**Output power supply**

Voltage range (AS-Interface net)	<b>AUX</b>
Voltage range	24 V DC
Potential separation	10-30 V
Reverse polarity protection	present
Indication	yes/electronic
	LED, green

**Outputs**

Rated output voltage	<b>Type 2 Acc. to IEC 61131-2</b>
Short circuit-proof	2 A per channel
Max. output current	yes
Overload-proof	4 A per module
Number of digital channels	yes
Channel type N.O.	4
Channel status indicator	PNP
	LED, yellow per channel

**Diagnostic**

Indication	LED, red
------------	----------

**Note:**

*The input channels are connected together providing for a greater connection flexibility (see pin assignment). In case of connection of a two-channel sensor to input socket 1 or 3 additional sensors must not be plugged into the input socket 2 or 4 respectively due to the Y (cross) wiring of the inputs.*

**Part Number**

0910 ASL 424



**0910 ASL 425** Version 2.1 - 4 In / 4 Out

AS-Interface module with 4 digital inputs (PNP), 4 digital outputs (2A) and micro (M12) bus connecton. Features: Stainless steel housing for food&beverage industry applications AS-i profile V2.1, short circuit detection, protection degree IP 69K, shock and vibration protected by using potting technology.

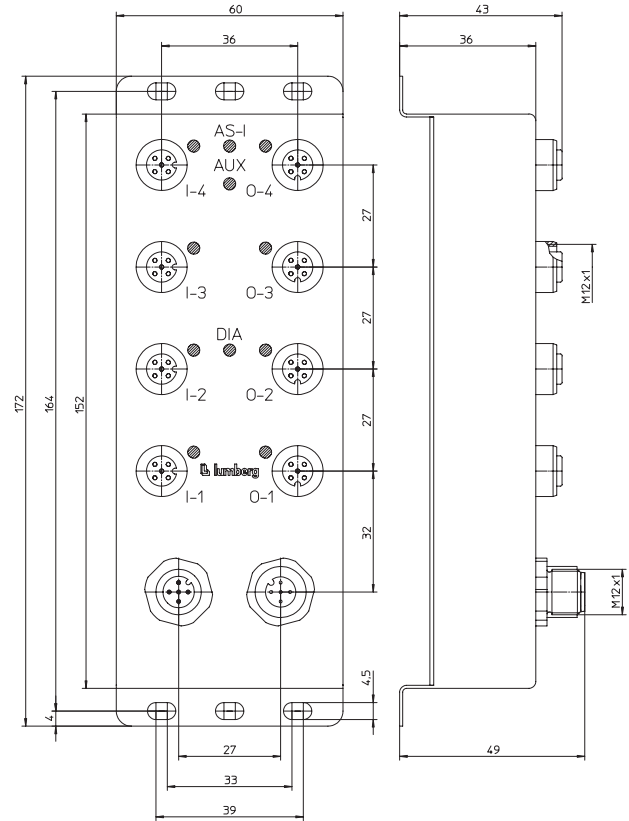

Bit Assignment								
Bit	-	-	-	-	3	2	1	0
<b>M12 Input</b>								
Byte 0	-	-	-	-	I-4	I-3	I-2	I-1
<b>M12 Output</b>								
Byte 0	-	-	-	-	O-4	O-3	O-2	O-1

Diagnostic Indication		
LED	Indication	Condition
I-1...4 / O-1...3	yellow	channel status
AS-i	green	AS-Interface power supply active
AUX	green	actuator supply active
DIA	red	communications error / address at 0
	red flashing	periphery error (actuator short circuit/sensor supply error)

Pin Assignment			
<p><b>Input 1 Micro (M12)</b></p> <ul style="list-style-type: none"> <li>1 = +24 V</li> <li>2 = n.c.</li> <li>3 = GND (0 V)</li> <li>4 = IN 1</li> <li>5 = earth</li> </ul>	<p><b>Input 2 Micro (M12)</b></p> <ul style="list-style-type: none"> <li>1 = +24 V</li> <li>2 = n.c.</li> <li>3 = GND (0 V)</li> <li>4 = IN 2</li> <li>5 = earth</li> </ul>	<p><b>Input 3 Micro (M12)</b></p> <ul style="list-style-type: none"> <li>1 = +24 V</li> <li>2 = n.c.</li> <li>3 = GND (0 V)</li> <li>4 = IN 3</li> <li>5 = earth</li> </ul>	<p><b>Input 4 Micro (M12)</b></p> <ul style="list-style-type: none"> <li>1 = +24 V</li> <li>2 = n.c.</li> <li>3 = GND (0 V)</li> <li>4 = IN 4</li> <li>5 = earth</li> </ul>
<p><b>Output 1 Micro (M12)</b></p> <ul style="list-style-type: none"> <li>1 = n.c.</li> <li>2 = n.c.</li> <li>3 = GND (0 V)</li> <li>4 = OUT 1</li> <li>5 = earth</li> </ul>	<p><b>Output 2 Micro (M12)</b></p> <ul style="list-style-type: none"> <li>1 = n.c.</li> <li>2 = n.c.</li> <li>3 = GND (0 V)</li> <li>4 = OUT 2</li> <li>5 = earth</li> </ul>	<p><b>Output 3 Micro (M12)</b></p> <ul style="list-style-type: none"> <li>1 = n.c.</li> <li>2 = n.c.</li> <li>3 = GND (0 V)</li> <li>4 = OUT 3</li> <li>5 = earth</li> </ul>	<p><b>Output 4 Micro (M12)</b></p> <ul style="list-style-type: none"> <li>1 = n.c.</li> <li>2 = n.c.</li> <li>3 = GND (0 V)</li> <li>4 = OUT 4</li> <li>5 = earth</li> </ul>

**Technical data**

Degree of protection	IP 69K
Operating temperature range	-25°C(+13°F) / +80°C (+158°)
Weight	550 g
Housing	Stainless Steel

**Bus system**

AS-Interface profile	<b>AS-Interface Version 2.1</b>
I/O configuration	S 7.F.E
ID code	7 hex
ID2 code (extended ID-code)	F hex
Support A/B addressing	E hex
	no

**Electronics power supply**

Rated voltage	<b>AS-Interface</b>
Voltage range	AS-Interface network
Power consumption	26.5 - 31.6 V DC
Reverse polarity protection	max. 310 mA
Indication	yes
	LED, green

**Input power supply**

Voltage range (AS-Interface net)	17-30 V
Total current of all sensors	max. 200 mA
Short circuit-proof	yes

**Inputs**

Rated input voltage	<b>Type 2 Acc. to IEC 61131-2</b>
Signal state "1"	24 V DC
Signal state "0"	Us > 10 V / Is > 4.7 mA
Input current at 24 V	Is < 1.5 mA
Input circuit	15 mA
Number of digital channels	PNP
Channel status indicator	4
	LED, yellow per channel

**Output power supply**

Voltage range (AS-Interface net)	<b>AUX</b>
Voltage range	24 V DC
Potential separation	10-30 V
Reverse polarity protection	present
Indication	yes/electronic
	LED, green

**Outputs**

Rated output voltage	<b>Type 2 Acc. to IEC 61131-2</b>
Short circuit-proof	2 A per channel
Max. output current	yes
Overload-proof	4 A per module
Number of digital channels	yes
Channel type N.O.	4
Channel status indicator	PNP
	LED, yellow per channel

**Diagnostic**

Indication	LED, red
------------	----------

**Note:**

*The input channels are connected together providing for a greater connection flexibility (see pin assignment). In case of connection of a two-channel sensor to input socket 1 or 3 additional sensors must not be plugged into the input socket 2 or 4 respectively due to the Y (cross) wiring of the inputs.*

**Part Number**

0910 ASL 425



**0915 034 101/...M**

AS-Interface PUR round cable ; double ended; molded male and female micro (M12) connectors, length 1M.

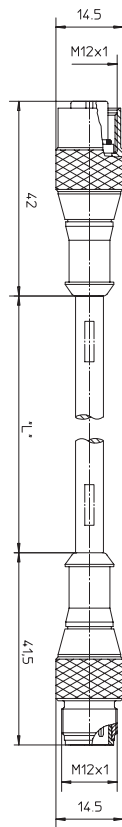
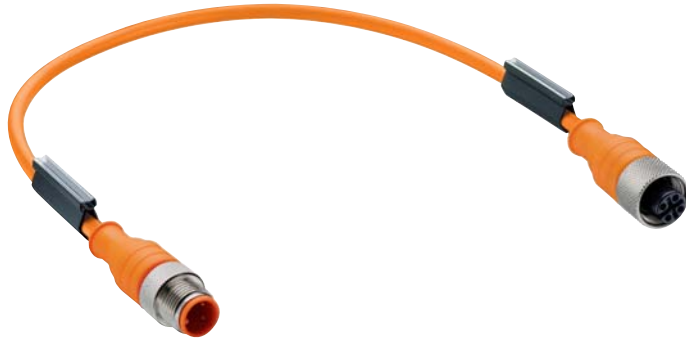

**Technical data**

Operating temperature range -25°C(+13°F) / +80°C (+158°)

**Materials**

Housing / molded body TPU, self-extinguishing  
 Insert TPU, self-extinguishing  
 Contact - male connector Brass, pre-nickeled and 0.8 microns gold-plated

Contact - female connector Brass, pre-nickeled and 0.3 microns gold-plated

Locking nut Brass, nickel plated  
 O-Ring Viton

**Mechanical data**

Degree of protection IP 67  
 (fully locked position only)

**Electrical data**

Contact resistance  $\leq 5\text{m}\Omega$   
 Nominal current at 40°C 4 A  
 Nominal voltage 240 V  
 Rated voltage 250 V  
 Test voltage 2.0 kV eff. / 60 s  
 Insulation resistance  $> 10^9 \Omega$

**Cable specifications**

Outer jacket PUR

**Pin Assignment** **Part Number**

**Micro (M12) - 4 poles**

0915 034 101/...M

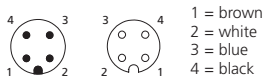

- 1 = brown
- 2 = white
- 3 = blue
- 4 = black

**Standard Cable Lengths: 0.3 M / 1 M / 2 M / 2.5 M / 3M / 4M / 6M**  
 Other cable lengths or cable specifications are available upon request.

**0915 097 000-50/...M**

AS-Interface rubber flat cable; yellow outer jacket for bus, 50m spool.

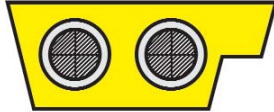

**0915 098 000-50/...M**

AS-Interface rubber flat cable; black outer jacket for auxiliary power, 50m spool.

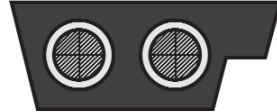

**0915 146 000-50/...M**

AS-Interface TPE flat cable; yellow outer jacket for bus, 50m spool.

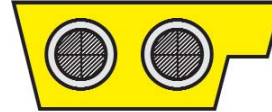

**0915 097 145-50/...M**

AS-Interface TPE flat cable; black outer jacket for auxiliary power, 50m spool.

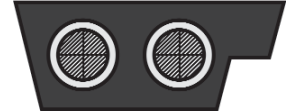

**Technical data**

Temperature range static -40°C (-40°F) / +80°C (+185° F)  
Temperature range moving -25°C (-13°F) / +85°C (+185° F)

**Materials**

Conductor 1.50mm<sup>2</sup>  
tin-coated, very finely stranded wires acc. to VDE 0295 KL6  
Insulation of lead rubber mixture  
Colors of the leads brown/blue  
Outer jacket rubber mixture  
color: yellow or black

**Electrical data**

Nominal voltage ≤ 300 V  
Test voltage 2.0 kV eff. / 60 s  
Insulation resistance ≤ 14 Ω/km

**Mechanical data**

Tensile strength 50N/mm<sup>2</sup> (during installation)  
Bending radius > 12 mm  
static and freely movable  
> 16 mm  
in case of C-track operation

**Further details**

Intended for indoor use. The use in open air requires conductors provided with black outer jacket.

**Technical data**

Temperature range static -40°C (-40°F) / +90°C (+194° F)  
Temperature range moving -30°C (-22°F) / +90°C (+194° F)

**Materials**

Conductor 1.50mm<sup>2</sup>  
tin-coated, very finely stranded wires acc. to VDE 0295 KL6  
Insulation of lead TPE  
Colors of the leads brown/blue  
Outer jacket TPE  
color: yellow or black

**Electrical data**

Nominal voltage ≤ 300 V  
Test voltage 2.0 kV eff. / 60 s  
Insulation resistance ≤ 14 Ω/km

**Mechanical data**

Tensile strength 50N/mm<sup>2</sup> (during installation)  
Bending radius > 12 mm  
static and freely movable  
> 16 mm  
in case of C-track operation

**Further details**

Resistance to oil acc. to DIN/VDE 0472-803. Inflammability acc. to FH 2-25, in compliance with IEC 707.

**Part Number**

0915 097 000-50/...M



0915 098 000-50/...M



0915 146 000-50/...M



0915 145 000-50/...M



**Standard Cable Lengths: 0.3 M / 1 M / 2 M / 2.5 M / 3M / 4M / 6M**

**Other cable lengths or cable specifications are available upon request.**

**0915 041 000/...M**

AS-Interface PUR/PVC round cable; orange outer jacket for bus.

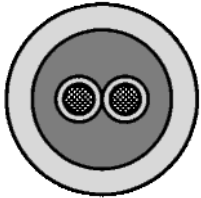

**Technical data**

Temperature range static -40°C (-40°F) / +90°C (+194° F)  
 Temperature range moving +5°C (-41°F) / +90°C (+194° F)

**Materials**

Conductor 1.50mm<sup>2</sup>  
 tin-coated, very finely stranded wires acc. to VDE 0295 KL6  
 Insulation of lead PVC  
 Colors of the leads brown/blue  
 Outer jacket PURE/PVC dull, color: orange, Ø 7.2 mm

**Electrical data**

Nominal voltage ≤ 300 V  
 Test voltage 2.0 kV eff. / 60 s  
 Resistance of conductor ≤ 13.7 Ω/km  
 Insulation resistance ≤ 10 MΩ/km

**Mechanical data**

Bending radius min 72 mm

**Further details**

Inflammability acc. to DIN VDE 0472-804 test type B. Increased resistance to oil acc. to VDE 0472-803. Good resistance to chemicals.

**Part Number**

0915 041 000/...M



**Standard Cable Lengths: 0.3 M / 1 M / 2 M / 2.5 M / 3M / 4M / 6M**  
 Other cable lengths or cable specifications are available upon request.



**0911 ANC 002**

AS-Interface passive distribution block, 4 female M12 connectors for AS-i hybrid round cable, molded, 6-pole M23 connector for auxiliary power supply.

**Technical data**

Operating temperature -25°C (-13°F) / +80°C (+176° F)

**Materials**

Housing material PUR  
 Outer jacket PUR/PVC

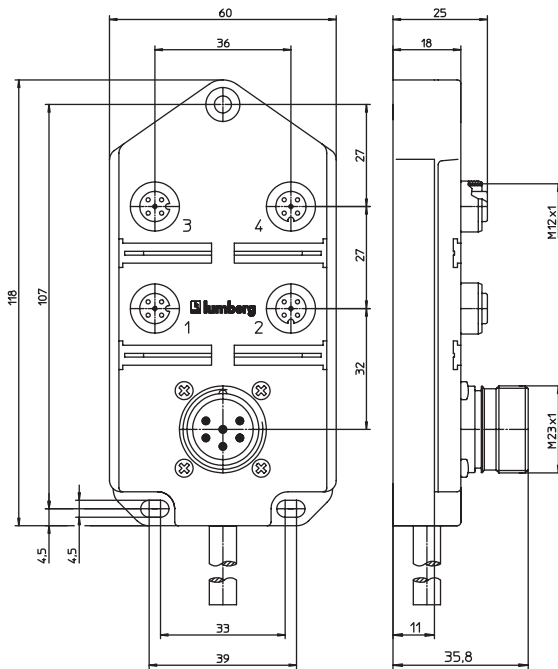

**Pin Assignments**

**Power Supply M23**

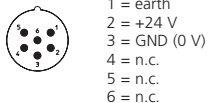

- 1 = earth
- 2 = +24 V
- 3 = GND (0 V)
- 4 = n.c.
- 5 = n.c.
- 6 = n.c.

**Input M12**



- 1 = AS-Interface +
- 2 = GND (0 V)
- 3 = AS-Interface -
- 4 = +24 V
- 5 = earth

**Part Number**

0911 ANC 002



**Standard Cable Lengths: 5 M / 10 M**  
 Other cable lengths or cable specifications are available upon request.

### 0911 ANC 403

AS-Interface passive distribution block, 4 female M12 connectors for AS-i hybrid flat cable connections for bus and auxiliary power supply.

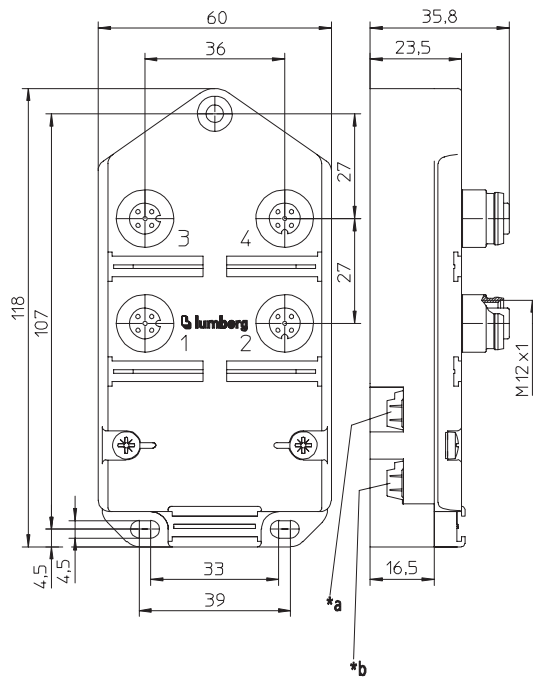

#### Technical data

Operating temperature -25°C (-13°F) / +80°C (+176° F)

#### Materials

Housing material PUR  
Outer jacket PUR/PVC

#### Pin Assignments

##### Input M12



- 1 = AS-Interface +
- 2 = GND (0 V)
- 3 = AS-Interface -
- 4 = +24 V
- 5 = earth

#### Part Number

0911 ANC 403



**0911 ANC 001/1.5 M**

AS-Interface flat cable junction, flat cable connection for bus and auxiliary power supply, molded AS-i hybrid round cable.

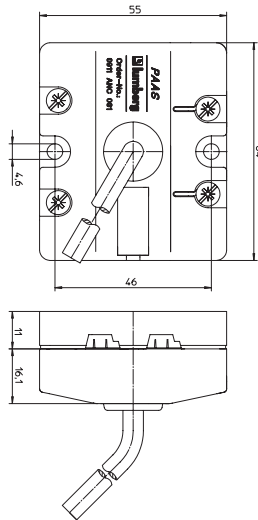

**Technical data**

Degree of protection	IP 65
Housing material	PUR
Nominal current	
0911 ANC 001	4 A
0911 ANC 101	
0911 ANC 401	8 A
Cable length	
0911 ANC 001	1.5 m

**0911 ANC 101**

AS-Interface flat cable junction, flat cable connection for bus and auxiliary power supply, molded AS-i hybrid round cable.

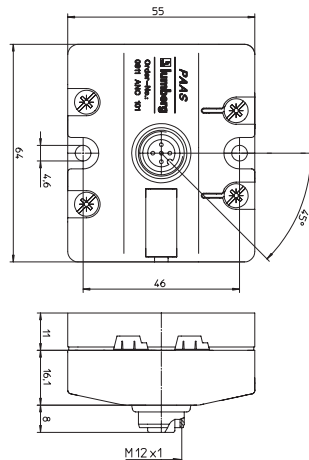

**0911 ANC 401**

AS-Interface flat cable junction, flat cable connection for bus or auxiliary power supply.

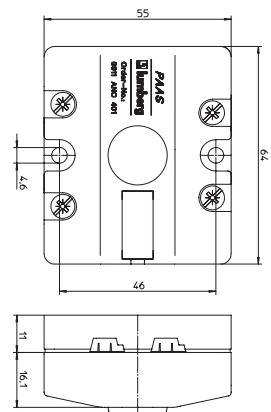

**Cable Assignments**

**Cable**

- 1 = AS-Interface +
- 2 = GND (0 V)
- 3 = AS-Interface -
- 4 = +24 V
- 5 = earth

- brown
- white
- blue
- black
- green/yellow

**Pin Assignments**

**Input M12**



- 1 = AS-Interface +
- 2 = GND (0 V)
- 3 = AS-Interface -
- 4 = +24 V
- 5 = earth

**Part Number**

0911 ANC 001/1.5M



0911 ANC 101



0911 ANC 401



### 0911 ANC 407

AS-Interface flat cable junction, single ended cable with piercing technology connector, PUR/PVC cable.



### 0911 ANC 410

AS-Interface flat cable junction, double ended cable with piercing technology connector, PUR/PVC cable.

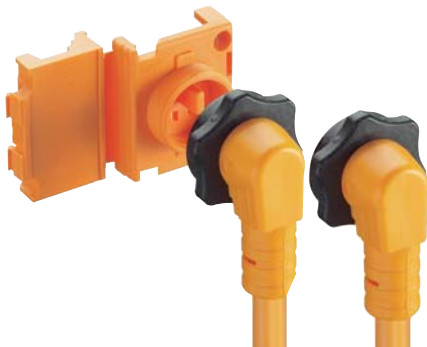

#### Technical data

Degree of protection	IP 67
Housing material	PA
Insert	PUR
Nominal current at 40° C	2 A / contact

#### Pin assignment

##### 2 Poles

- 1 = brown
- 2 = blue

#### Part Number

0911 ANC 407/...M

#### Outer jacket

PUR/PVC



Standard Cable Lengths: 0911 ANC 407: 2 M / 5 M / 10M

0911 ANC 410: 0.3M / 0.6M / 1M / 2M / 5M / 10M / 15M

**0911 ANC 408**

AS-Interface flat cable junction, female M12 connector with integrated piercing technology contacts for the flat cable.



**Technical data**

Degree of protection	IP 67
Molded body	PA
Insert	PA
Nominal current at 40° C	4 A

**0911 ANC 406**

AS-Interface flat cable junction, spare part for 0911 ANC 407/408/410.

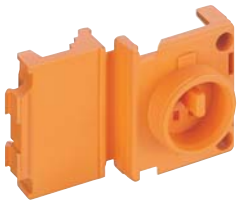

**Technical data**

Molded body	PA
-------------	----

**0911 ANC 413**

AS-Interface flat cable junction, female M12 connector with integrated piercing technology contacts for the flat cable. Stainless steel metal parts, IP69K rated, for food&beverage applications.



**Technical data**

Degree of protection	IP 67/IP 69 K
Molded body	PBT
Insert	PBT
Nominal current at 40° C	4 A

**0911 ANC 415**

AS-Interface flat cable junction, spare part for 0911 ANC 413. Stainless steel metal parts, IP69K rated, for food&beverage applications.



**Technical data**

Molded body	PBT
-------------	-----

Part Number	Outer jacket	
0911 ANC 408	0911 ANC 406	 
0911 ANC 413	0911 ANC 415	 

**0913 ATL 003**

AS-Interface addressing handheld, AS-i profile V2.1, direct connection for round cable modules.



**0913 ATL 002/0.35 M**

AS-Interface addressing adapter for 0913 ATL 003 for the Lumberg flat cable modules with AS-i profile V2.1.



**0913 ATL 004/1 M**

AS-Interface addressing adapter for 0913 ATL 003 for modules with AS-i profile V2.1.



**Important Note:**

The equipment with profile V2.1 is not addressable with the previous address module 0913 ATL 001.

**0911 ANC 409**

Terminal sleeve for flat cables.



**ZBS**

Attachable labels, 10 pieces (7 x 14mm).



**ZVK**

Dust cover for unused M12 sockets.



Part Number	Outer jacket
0913 ATL 003	
0913 ATL 002/0.35 M	0913 ATL 004/1 M
0911 ANC 409	
ZBS	
ZVK	



New Part Number	Old Part Number	Page	New Part Number	Old Part Number	Page
0910 ASL 132	0910 ASL 112	14-15	0911 ANC 406		45
0910 ASL 133	0910 ASL 111	20-21	0911 ANC 407/...M		44
0910 ASL 134	0910 ASL 110	26-27	0911 ANC 408		45
0910 ASL 135	0910 ASL 109	32-33	0911 ANC 409		46
0910 ASL 403		18-19	0911 ANC 410/...M		44
0910 ASL 408		30-31	0911 ANC 413		45
0910 ASL 409		12-13	0911 ANC 415		45
0910 ASL 410		24-25	0913 ATL 002		46
0910 ASL 412		16-17	0913 ATL 003		46
0910 ASL 414		28-29	0913 ATL 004		46
0910 ASL 419		22-23	0915 034 101		38
0910 ASL 424		34-35	0915 041 000		40
0910 ASL 425		36-37	0915 097 000-50 M		39
0910 ASL 501		10-11	0915 098 000-50 M		39
0911 ANC 001		43	0915 145 000-50 M		39
0911 ANC 002		41	0915 146 000-50 M		39
0911 ANC 101		43	ZBS		46
0911 ANC 401		43	ZVK		46
0911 ANC 403		42			

The policy of **Lumberg, Inc.** is to sell our products through Authorized Stocking Distributors. Our distributors provide the market with technical support, service, and local stock. For application assistance or for the location of your nearest Lumberg, Inc. Distributor, please visit our website:

**[www.lumbergusa.com](http://www.lumbergusa.com)**

Specifications in this manual are subject to change without notice. Lumberg, Inc. also reserves the right to make modifications and makes no guarantee to the accuracy of the information contained herein. Lumberg's Warranty, Terms and Conditions apply.

For literature and media questions or concerns:  
 Contact Marketing Communications at **[info@lumbergusa.com](mailto:info@lumbergusa.com)**



**Lumberg, Inc., Automation Components**

14121 Justice Road  
 Midlothian, VA 23113 - USA  
 Phone + 1 804 379 2010  
 Fax + 1 804 379 3232  
 E-mail info@lumbergusa.com



**Lumberg Automation Components GmbH & Co. KG**

Im Gewerbepark 2  
 58579 Schalksmühle  
 Postfach 13 60  
 58569 Schalksmühle - GERMANY  
 Phone +49 (0) 23 55 - 83-01  
 Fax +49 (0) 23 55 - 83-263  
 E-mail info@lumberg.de



**Fieldbus Communications - AS-Interface**

www.lumbergusa.com